

MET VISIE OP HEF EN HIJSWERKTUIGEN

AVEC UNE VISION SUR LES ÉQUIPEMENTS DE LEVAGE ET D'ÉLÉVATION

WITH VISION ON LIFTING AND HOISTING EQUIPMENT



Vabotec BV
Starrenhoflaan 33
2950 Kapellen-Antwerpen
België/Belgique
info@vabotec.be
www.vabotec.be
BTW/TVA BE 0479 973 519
Tel 0032 3 660 08 94

INHOUDSOPGAVE - TABLE DES MATIERES - TABLE OF CONTENTS

	Nieuwe Producten	Nouveau produits	New products	
1	Hijbsbanden	Sangles de levage	Webbing slings	4 5 - 8
2	Rondstroppen	Elingues rondes	Round slings	9 - 12
3	Sjorbanden	Sangles d'arrimage	Cargo lashings	13 - 21
4	Beschermingsmaterialen	Accessoires de protection	Protection accessories	22
5	Sjorkettingen NIEUW	Chaînes d'arrimage NOUVEAU	Cargo lashing chains NEW	23 - 27
6	Kettingmateriaal GR 80	Accessoires de chaînes GR 80	Accessories for chain GR 80	28 - 38
7	Kettingmateriaal GR 100	Accessoires de chaînes GR 100	Accessories for chain GR 100	39 - 43
8	Sluitingen	Manilles	Shackles	44 - 47
9	Kettingsamenstellingen	Compositions de chaînes	Chain compositions	48 - 74
10	Handkettingtakels	Palans manuel à chain	Manual chain hoists	75 - 76
11	Rateltakels	Palans à levier	Lever hoists	77
12	Hefmagneten NIEUW	Aimants permanents NOUVEAU	Permanent magnetic lifters NEW	80
13	Balkenklemmen	Pinces à profile	Beam clamps	81
14	Verticale platenklemmen	Pinces de levage verticale	Vertical plate clamps	82
15	Horizontale platenklemmen NIEUW	Pinces de levage horizontale NOUVEAU	Horizontal plate clamps NEW	82-84
16	Railklemmen NIEUW	Pinces de levage pour rails NOUVEAU	Rail clamps NEW	84



Vabotec is niet aansprakelijk voor drukfouten in deze prijslijst.

Vabotec n'est pas responsable pour des erreurs dans cet liste de tarifs.

Vabotec isn't responsible for errors in this price list.

INHOUDSOPGAVE - TABLE DES MATIERES - TABLE OF CONTENTS

17	Loopkatten	Chariots manuels	Plain trolleys	85
18	Dommekrachten	Crics à crémaillère	Rack jacks	86
19	Hydraulische vijzels NIEUW	Vérins hydraulique NOUVEAU	Hydraulic jacks NEW	86
20	Potkrik - Fleskrik	Cric hydraulique/bouteille	Bottle jack/Hydraulic jack	87
21	Elektrische kettingtakels	Palans électrique	Electric chain hoist	88 - 89
22	Elektrische loopkatten	Charriots électrique	Electrical beam trolleys	90
23	Staaldraadtakels	Tireurs à câble	Wire rope pulling hoists	91
24	Kabelschijven	Poullies	Snatch blocks	92
25	Laadindicators	Indicateurs de charge	Load indicators	93
26	Lieren	Treuels	Winches	94 - 96
27	Zwenkkranen	Potences	Jib cranes	97 - 98
28	Algemene verkoopvoorwaarden	Conditions générales de vente	General terms and conditions	99 - 104



Prijzen onder voorbehoud, exclusief BTW en exclusief transportkosten. Opdrachtbevestigingen zijn geldig.

Prix sous réservation, hors TVA et hors frais de transport. La confirmation de commande est valide.

Prices subject to change, excluding VAT and excluding Transport costs. Order confirmations are applicable.

Maatwerk wordt niet teruggenomen - Travail sur mesure est non retournable - Custom made works won't be taken back.

Nieuwe producten - nouveau produits - new products

VAB Topschalmen met geïntegreerde inkorthaken G80 - VAB Mailles de tête avec raccourcisseur intégré

VAB Masterlinks with integrated shortening hooks G80



Beschikbaar in : 6mm, 8mm, 10mm & 13mm

Disponible en : 6mm, 8mm, 10mm & 13mm

Available in : 6mm, 8mm, 10mm & 13mm

Kettingleng - tweesprong - viersprong

Élingue chaîne 1 brin, 2 brins, 4 brins

Single legged chain, 2 legged, 4 legged

VAB Sjorkettingsamenstellingen - VAB Compositions chaînes d'arrimage - VAB Cargo lashing chain assemblies



Beschikbaar in : 8mm, 10mm & 13mm

Disponible en : 8mm, 10mm & 13mm

Available in : 8mm, 10mm & 13mm

Gieterijhaak, haak met klep en veiligheidshaak

Crochet de fonderie, crochet avec languet et crochet à verrouillage

Foundry hook, latch hook and safety hook with spring



Code	L	Tonnage	Bruto €	EAN CODE	
HBDTL010005	0,5 m	1 Ton Paars / Violet / Purple	4,30		
HBDTL010010	1 m		4,40		
HBDTL010015	1,5 m		5,10		
HBDTL010020	2 m		5,95		
HBDTL010025	2,5 m		7,80		
HBDTL010030	3 m		7,90		
HBDTL010040	4 m		12,00		
HBDTL010050	5 m		14,15		
HBDTL010060	6 m		16,55		
HBDTL010070	7 m		18,10		
HBDTL010080	8 m		20,31		
HBDTL010090	9 m		22,49		
HBDTL010100	10 m		26,13		



HBDTL020005	0,5 m	2 Ton Groen / Vert / Green	7,20		
HBDTL020010	1 m		7,60		
HBDTL020015	1,5 m		10,64		
HBDTL020020	2 m		11,20		
HBDTL020025	2,5 m		13,25		
HBDTL020030	3 m		14,30		
HBDTL020040	4 m		17,95		
HBDTL020050	5 m		23,00		
HBDTL020060	6 m		25,55		
HBDTL020070	7 m		28,25		
HBDTL020080	8 m		31,65		
HBDTL020090	9 m		35,75		
HBDTL020100	10 m		38,15		



Code	L	Tonnage	Bruto €	EAN CODE	
HBDTL030010	1 m	3 Ton Geel / Jaune / Yellow	8,55		
HBDTL030015	1,5 m		13,60		
HBDTL030020	2 m		20,31		
HBDTL030025	2,5 m		22,30		
HBDTL030030	3 m		23,25		
HBDTL030040	4 m		26,31		
HBDTL030050	5 m		32,68		
HBDTL030060	6 m		39,75		
HBDTL030070	7 m		51,90		
HBDTL030080	8 m		60,48		
HBDTL030090	9 m		67,23		
HBDTL030100	10 m		74,48		



Code	L	Tonnage	Bruto €	EAN CODE	
HBDTL040020	2 m	4 Ton Grijs / Gris / Grey	27,95		
HBDTL040025	2,5 m		31,50		
HBDTL040030	3 m		32,60		
HBDTL040040	4 m		38,70		
HBDTL040050	5 m		47,30		
HBDTL040060	6 m		55,25		
HBDTL040070	7 m		63,30		
HBDTL040080	8 m		69,65		
HBDTL040090	9 m		81,85		
HBDTL040100	10 m		84,15		











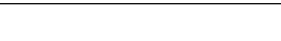









Code	L	Tonnage	Bruto €	EAN CODE	
HBDTL050020	2 m	5 Ton Rood / Rouge / Red	25,60		
HBDTL050030	3 m		35,66		
HBDTL050040	4 m		49,00		
HBDTL050050	5 m		56,00		
HBDTL050060	6 m		64,86		
HBDTL050070	7 m		68,45		
HBDTL050080	8 m		74,40		
HBDTL050090	9 m		78,54		
HBDTL050100	10 m		96,00		



















HBDTL060020	2 m	6 Ton Bruin / Brun / Brown	36,50		
HBDTL060030	3 m		55,10		
HBDTL060040	4 m		70,86		
HBDTL060050	5 m		79,00		
HBDTL060060	6 m		89,85		
HBDTL060070	7 m		103,00		
HBDTL060080	8 m		108,00		
HBDTL060090	9 m		121,00		
HBDTL060100	10 m		142,00		



Code	L	Tonnage	Bruto €	EAN CODE	
HBDTL080020	2 m	8 Ton Blauw / Bleu / Blue	71,00		
HBDTL080030	3 m		76,00		
HBDTL080040	4 m		84,00		
HBDTL080050	5 m		96,00		
HBDTL080060	6 m		133,00		
HBDTL080070	7 m		139,00		
HBDTL080080	8 m		146,60		
HBDTL080090	9 m		178,40		
HBDTL080100	10 m		223,31		



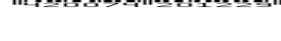









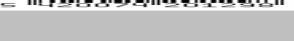

HBDTL100020	2 m	10 Ton Oranje / Orange / Orange	62,06		
HBDTL100030	3 m		84,31		
HBDTL100040	4 m		104,43		
HBDTL100050	5 m		112,50		
HBDTL100060	6 m		130,40		
HBDTL100070	7 m		153,30		
HBDTL100080	8 m		179,20		
HBDTL100090	9 m		194,00		
HBDTL100100	10 m		212,80		













Afwijkende maten worden niet vermeld. Prijzen steeds verkrijgbaar op aanvraag! Producten kunnen afwijken tegenover de foto's.
Des mesures irrégulières ne sont pas mentionnées. Prix toujours disponible sur demande! Les produits peuvent différer des photos.
Deviant dimensions are not mentioned. Price always available on request! Products may differ from the photos.



















Code	L	Tonnage	Bruto €	EAN CODE
RS010005	0,5 m	1 Ton Paars / Violet / Purple	2,96	
RS010010	1 m		4,56	
RS010015	1,5 m		6,36	
RS010020	2 m		7,96	
RS010025	2,5 m		9,72	
RS010030	3 m		11,90	
RS010040	4 m		15,90	
RS010050	5 m		19,15	
RS010060	6 m		21,62	
RS010070	7 m		23,39	
RS010080	8 m		28,70	
RS010090	9 m		28,85	
RS010100	10 m		32,15	















RS020005	0,5 m	2 Ton Groen / Vert / Green	3,91	
RS020010	1 m		6,43	
RS020015	1,5 m		9,01	
RS020020	2 m		11,49	
RS020025	2,5 m		14,14	
RS020030	3 m		17,20	
RS020040	4 m		23,25	
RS020050	5 m		27,00	
RS020060	6 m		33,10	
RS020070	7 m		34,95	
RS020080	8 m		39,60	
RS020090	9 m		46,58	
RS020100	10 m		48,72	



Code	L	Tonnage	Bruto €	EAN CODE
RS030005	0,5 m	3 Ton Geel / Jaune / Yellow	5,54	
RS030010	1 m		8,94	
RS030015	1,5 m		12,48	
RS030020	2 m		15,95	
RS030025	2,5 m		19,59	
RS030030	3 m		23,29	
RS030040	4 m		30,46	
RS030050	5 m		37,71	
RS030060	6 m		48,13	
RS030070	7 m		52,94	
RS030080	8 m		56,20	
RS030090	9 m		63,80	
RS030100	10 m		74,10	



RS040010	1 m	4 Ton Grijs / Gris / Grey	11,15	
RS040015	1,5 m		15,91	
RS040020	2 m		20,57	
RS040025	2,5 m		25,23	
RS040030	3 m		29,92	
RS040040	4 m		39,51	
RS040050	5 m		48,86	
RS040060	6 m		58,24	
RS040070	7 m		67,63	
RS040080	8 m		72,32	
RS040090	9 m		77,01	
RS040100	10 m		85,00	



Code	L	Tonnage	Bruto €	EAN CODE
RS050010	1 m	5 Ton Rood / Rouge / Red	20,05	
RS050015	1,5 m		21,65	
RS050020	2 m		26,58	
RS050030	3 m		39,00	
RS050040	4 m		51,30	
RS050050	5 m		59,98	
RS050060	6 m		71,57	
RS050070	7 m		77,38	
RS050080	8 m		83,23	
RS050090	9 m		89,08	
RS050100	10 m		118,24	



RS060020	2 m	6 Ton Bruin / Brun / Brown	32,20	
RS060030	3 m		46,85	
RS060040	4 m		58,31	
RS060050	5 m		72,28	
RS060060	6 m		86,22	
RS060070	7 m		93,30	
RS060080	8 m		103,02	
RS060090	9 m		116,72	
RS060100	10 m		130,25	



Code	L	Tonnage	Bruto €	EAN CODE
RS080020	2 m	8 Ton Blauw / Bleu / Blue	40,83	
RS080030	3 m		59,09	
RS080040	4 m		77,83	
RS080050	5 m		96,22	
RS080060	6 m		115,02	
RS080070	7 m		124,44	
RS080080	8 m		133,82	
RS080090	9 m		143,24	
RS080100	10 m		152,66	



RS100020	2 m	10 Ton Oranje / Orange / Orange	48,13	
RS100030	3 m		70,01	
RS100040	4 m		92,52	
RS100050	5 m		115,27	
RS100060	6 m		137,82	
RS100070	7 m		160,45	
RS100080	8 m		183,08	
RS100090	9 m		171,77	
RS100100	10 m		183,08	



Afwijkende maten worden niet vermeld. Prijzen steeds verkrijgbaar op aanvraag! Producten kunnen afwijken tegenover de foto's.
Des mesures irrégulières ne sont pas mentionnées. Prix toujours disponible sur demande! Les produits peuvent différer des photos.
Deviant dimensions are not mentioned. Price always available on request! Products may differ from the photos.

Afwijkende maten worden niet vermeld. Prijzen steeds verkrijgbaar op aanvraag!
Des mesures irréguliers ne sont pas mentionnées. Prix toujours disponible sur demande!
Deviant dimensions are not mentioned. Price always available on request!

Verschillende types - Types différents - Various types



MOVE-IT Sjorbanden met ratel brede haak - Sangles d'arrimages avec racagnac et crochet ouvert - Cargolashings with ratchet open hook



Brede haken worden onder het chassis van het voertuig vastgehaakt.
De larges crochets sont accrochés sous le châssis du véhicule.
Wide hooks are hooked under the chassis of the vehicle.

Sjorbanden ratel brede haak
Sangles d'arrimages avec racagnac et crochet ouvert
Cargolashings with ratchet open hook

Standard handle



SJBH050

50 mm

Sjorbanden ratel brede haak
Sangles d'arrimages avec racagnac et crochet ouvert
Cargolashings with ratchet open hook

Long handle (LH)



SJBHLH050

50 mm

Sjorbanden ratel brede haak
Sangles d'arrimages avec racagnac et crochet ouvert
Cargolashings with ratchet open hook

Ergo handle (EH)



SJBHEH050

50 mm



MOVE-IT Sjorbanden met ratel smalle haak - Sangles d'arrimages avec racagnac et crochet fermé - Cargolashings with ratchet double closed J-hook



**Sjorbanden met ratel smalle haak
Sangles d'arrimages avec racagnac et crochet fermé
Cargolashings with ratchet double closed J-hook**



SJSH005

25 mm

**Sjorbanden met ratel smalle haak
Sangles d'arrimages avec racagnac et crochet fermé
Cargolashings with ratchet double closed J-hook**



SJSH015

25 mm

**Sjorbanden met ratel smalle haak
Sangles d'arrimages avec racagnac et crochet fermé
Cargolashings with ratchet double closed J-hook**



SJSH025

35 mm

**Sjorbanden met ratel smalle haak
Sangles d'arrimages avec racagnac et crochet fermé
Cargolashings with ratchet double closed J-hook**



SJSH050

50 mm



**MOVE-IT Sjorbanden met ratel smalle haak - Sangles d'arrimages avec racagnac et crochet fermé -
Cargolashings with ratchet double closed J-hook**



**Sjorbanden met ratel smalle haak
Sangles d'arrimages avec racagnac et crochet fermé
Cargolashings with ratchet double closed J-hook**

Long Handle (LH)



SJBHLH050

50 mm

**Sjorbanden met ratel smalle haak
Sangles d'arrimages avec racagnac et crochet fermé
Cargolashings with ratchet double closed J-hook**

Ergo Handle (EH)



SJBHEH050

50 mm

**Sjorbanden met ratel smalle haak
Sangles d'arrimages avec racagnac et crochet fermé
Cargolashings with ratchet double closed J-hook**



SJSH100

75 mm

Afwijkende maten worden niet vermeld. Prijzen steeds verkrijgbaar op aanvraag! Producten kunnen afwijken tegenover de foto's.
Des mesures irréguliers ne sont pas mentionnées. Prix toujours disponible sur demande! Les produits peuvent différer des photos.
Deviant dimensions are not mentioned. Price always available on request! Products may differ from the photos.



**MOVE-IT Sjorbanden met ratel eindloos - Sangles d'arrimages à racagnac sans fin -
Cargolashings with ratchet endless**



**Sjorbanden met ratel eindloos
Sangles d'arrimages à racagnac sans fin
Cargolashings with ratchet endless**



SJEL005

25 mm

**Sjorbanden met ratel eindloos
Sangles d'arrimages à racagnac sans fin
Cargolashings with ratchet endless**



SJEL015

25 mm

**Sjorbanden met ratel eindloos
Sangles d'arrimages à racagnac sans fin
Cargolashings with ratchet endless**



SJEL025

35 mm

**Sjorbanden met ratel eindloos
Sangles d'arrimages à racagnac sans fin
Cargolashings with ratchet endless**



SJEL050

50 mm

**MOVE-IT Sjorbanden tweedelig met railfitting - Sangles d'arrimages double avec railfitting -
Cargolashings twofold with railfitting**

**Sjorbanden tweedelig met railfitting
Sangles d'arrimages double avec railfitting
Cargolashings twofold with railfitting**



SJRF050

50 mm

**MOVE-IT Sjorbanden maatwerk - Sangles d'arrimages sur demande et sur mesure -
Cargolashings on request and to personal requirements**

**Sjorbanden met smalle haak en brede haak
Sangles d'arrimages avec crochet ouvert et fermée
Cargolashings with integrated open and closed J-hook**

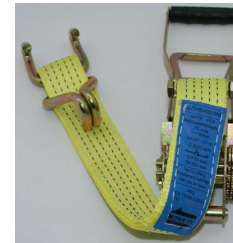

Bruikbaar voor sjorpunten en chassis
Peut être utilisé pour les points d'arrimage et le châssis
To be used both in lifting points and chassis

In verscheidene maten verkrijgbaar. Prijzen steeds verkrijgbaar op aanvraag!
Variété de dimensions disponible. Prix toujours disponible sur demande!
Various dimension available. Price always available on request!

MOVE-IT Bagagegordels eindloos met klemgesp - Sangles à bagage sans fin à came - Cargolashings endless with cam lock



Code	L	B - WLL/CMU kg	Bruto €	EAN CODE
SJBG015	1,5 m	25 mm WLL/CMU kg 500 daN	2,59	
SJBG020	2 m		2,67	
SJBG030	3 m		2,87	
SJBG040	4 m		3,20	
SJBG050	5 m		3,44	
SJBG060	6 m		3,68	



MOVE-IT Sjorbanden met ratel brede haak - Sangles d'arrimages avec racagnac et crochet ouvert - Cargolashings with ratchet open J-hook



NIEUW
NOUVEAU
NEW

Code	L	B - WLL/CMU kg	Bruto €	EAN CODE
SJBH025060	6 m	35 mm - 1250daN	13,00	
SJBH05060	6 m	50 mm 2000 daN	15,60	
SJBH05090	9 m		18,50	
SJBH050120	12 m		23,75	
STANDARD RATCHET				
SJBHLH050090	9 m	50 mm - 2000 daN	25,35	
EXTRA LONG HANDLE RATCHET				
SJBHEH050090	9 m	50 mm - 2000 daN	25,35	
ERGO LONG HANDLE RATCHET				



**MOVE-IT Sjorbanden met ratel smalle haak - Sangles d'arrimages avec racagnac et crochet fermé -
Cargolashings with ratchet double closed J-hook**

Code	L	B - WLL/CMU kg	Bruto €	EAN CODE
SJSH005040	4 m	25 mm	4,75	
SJSH005060	6 m	400 daN	5,14	



SJSH015040	4 m	25 mm	7,35	
SJSH015060	6 m	750 daN	7,99	
SJSH015080	8 m		9,50	



SJSH025040	4 m	35 mm	11,00	
SJSH025060	6 m	1250 daN	13,00	
SJSH025080	8 m		13,80	



SJSH05060	6 m	50 mm	15,60	
SJSH05090	9 m	2000 daN	18,50	
SJSH050120	12 m		23,75	
SJSH050150	15 m		27,00	

STANDARD RATCHET

**MOVE-IT Sjorbanden met ratel smalle haak - Sangles d'arrimages avec racagnac et crochet fermé -
Cargolashings with ratchet double closed J-hook**

Code	L	B - WLL/CMU kg	Bruto €	EAN CODE
SJSHLH050090	9 m	50 mm - 2000 daN	25,35	

ERGO LONG HANDLE RATCHET



SJSHEH050090	9 m	50 mm - 2000 daN	25,35	
--------------	-----	------------------	-------	--

EXTRA LONG HANDLE RATCHET

SJSH10009	9 m	75 mm - 5000 daN	73,75	
SJSH10012	12 m		81,00	

STANDARD RATCHET

**MOVE-IT Sjorbanden met ratel eindloos - Sangles d'arrimages avec racagnac sans fin -
Cargolashings with ratchet endless**

Code	L	B - WLL/CMU kg	Bruto €	EAN CODE
SJEL005015	1,5 m	25 mm - 800 daN	3,85	
SJEL005025	2,5 m		4,10	
SJEL005045	4,5 m		4,90	
SJEL005060	6 m		5,35	



SJEL015030	3 m	25 mm - 1500 daN	5,30	
SJEL015035	3,5 m		5,90	
SJEL015050	5 m		7,95	
SJEL015070	7 m		9,15	



SJEL025050	5 m	35 mm - 2500 daN	9,98	
SJEL025070	7 m		11,28	



SJEL05030	3 m	50 mm - 4000 daN	12,44	
SJEL05060	6 m		16,35	
SJEL05090	9 m		20,87	

MOVE-IT Sjorbanden tweedelig met railfitting - Sangles d'arrimages double avec railfitting - Cargolashings twofold with railfitting



Code	L	B - WLL/CMU kg	Bruto €	EAN CODE
SJRF05050	5 m	50 mm - 2000 daN	15,00	
SJRF05070	7 m		17,00	

MOVE-IT Sjorbanden maatwerk - Sangles d'arrimages sur demande et sur mesure - Cargolashings on request and to personal requirements

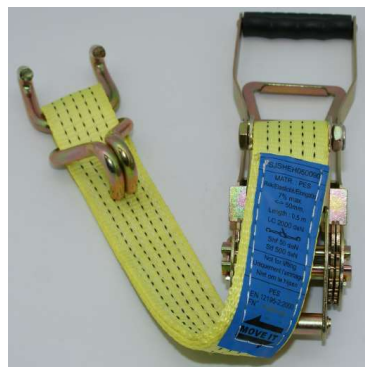

Voor maatwerk kan U ons altijd contacteren.
Wij luisteren graag naar uw noden

Pour la travail sur demande et sur mesure, vous pouvez toujours nous contacter.
Nous sommes à l'écoute de vos besoins.

For custom made works you can always contact us.
We are happy to listen to your needs.





**Kunststof hoekbeschermers - Coins de protection en matière synthétique -
Synthetic corner protection**

Code	L x B	H	Bruto €	EAN CODE
HBK6003	160 x 190	150	3,1	
HBK6008	90 x 90	130	1,35	
HBK8000	5800 x 190	190	157	

Antislipmatten - Mats non-slip - Non-skid mats

In verscheidene maten verkrijgbaar. Prijzen steeds verkrijgbaar op aanvraag!
Variété de dimensions disponible. Prix toujours disponible sur demande!
Various dimension available. Price always available on request!

Code	L x H	B	€ / rol	EAN CODE
SLIP06X15X8	6000 x 150	8 mm	34	
SLIP20X15X3	20000 x 150	3 mm	34	

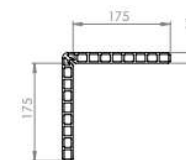
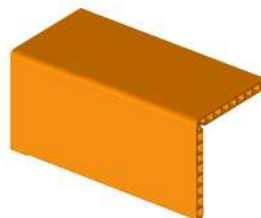
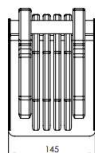
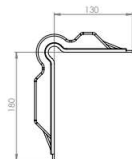

Afwijkende maten worden niet vermeld. Prijzen steeds verkrijgbaar op aanvraag!
Des mesures irrégulières ne sont pas mentionnées. Prix toujours disponible sur demande!
Deviant dimensions are not mentioned. Price always available on request!

Verschillende types - Types différents - Various types

**VAB Sjorkettingen met gieterijhaak aan één of beide zijden - VAB Chaînes d'arrimages avec 1 ou 2 crochets de fonderie -
VAB Cargo lashing chains with foundry hook at one or both sides**



**VAB Sjorkettingen met haakklep aan één of beide zijden - VAB Chaînes d'arrimages avec 1 ou 2 crochets avec linguet -
VAB Cargo lashing chains with clevis latch hooks at one or both sides**



**VAB Sjorkettingen met veiligheids aan één of beide zijden - VAB Chaînes d'arrimages avec 1 ou 2 crochets à chape -
VAB Cargo lashing chains with clevis safety hooks at one or both sides**



5 Sjorkettingen - Chaînes d'arrimage - Cargo securing chains Norm EN 12195-3

Afwijkende maten worden niet vermeld. Prijzen steeds verkrijgbaar op aanvraag!
 Des mesures irrégulières ne sont pas mentionnées. Prix toujours disponible sur demande!
 Deviant dimensions are not mentioned. Price always available on request!

VAB Ratelvrachtspanner - Kettingspanners - VAB Tendeurs d'arrimage pour chaînes - VAB Chain load binders with ratchet and hook



Code	Ø	WLL/CMU kg	Bruto €	EAN CODE
KMRS08	8 mm	2450	41,00	
KMRS10	10 mm	4175	50,00	
KMRS13	13 mm	5900	87,00	

KMRS06 - 6mm - wordt verwacht einde 2022 ! KMRS06 - 6mm - attendu fin 2022 ! KMRS06 - 6mm - is expected at the end of 2022 !

VAB Ratelvrachtspanner - Kettingspanners - VAB Tendeurs d'arrimage pour chaînes - VAB Chain load binders with ratchet and hook



Aangepast naar de wensen van de klant.
 Adapté aux specifications du client.
 Adapted to the specifications of the customer.





Opties / Les options / Options

- Met gieterijhaken With foundry hooks
- Met kettingverlenging With chain extension
- Met haakklep of veiligheidshaak With latch or safety hooks
- Avec crochets de fonderie
- Avec extension de chaîne
- Avec crochet avec linguet ou crochet de sécurité

Alle kettingen worden voorzien van verplicht label volgens EN12195-3
 Toutes les chaînes sont étiquetées conformément à la norme EN12195-3.
 All chains are provided with a label in line with the EN12195-3 directive.

GRADE 80

... met gieterijhaak / avec crochet de fonderie / with foundry hook

	Code	Bruto €	Omschrijving / Description / Description	L	Code	Bruto €
	SJKS108-1xGH10	61	8 mm WLL/CMU kg 4000daN	1 m	SJKS108-2xGH10	81
	SJKS108-1xGH15	66		1,5 m	SJKS108-2xGH15	86
	SJKS108-1xGH20	71		2 m	SJKS108-2xGH20	91
	SJKS108-1xGH25	76		2,5 m	SJKS108-2xGH25	96
	SJKS108-1xGH30	81		3 m	SJKS108-2xGH30	101
	SJKS108-1xGH35	86		3,5 m	SJKS108-2xGH35	106
	SJKS108-1xGH40	91		4 m	SJKS108-2xGH40	111
	SJKS110-1xGH10	61	10 mm WLL/CMU kg 6300daN	1 m	SJKS110-2xGH10	106
	SJKS110-1xGH15	66		1,5 m	SJKS110-2xGH15	113
	SJKS110-1xGH20	71		2 m	SJKS110-2xGH20	120
	SJKS110-1xGH25	76		2,5 m	SJKS110-2xGH25	127
	SJKS110-1xGH30	81		3 m	SJKS110-2xGH30	134
	SJKS110-1xGH35	86		3,5 m	SJKS110-2xGH35	141
	SJKS110-1xGH40	91		4 m	SJKS110-2xGH40	148
	SJKS113-1xGH10	108	13 mm WLL/CMU kg 10600daN	1 m	SJKS113-2xGH10	159
	SJKS113-1xGH15	120		1,5 m	SJKS113-2xGH15	171
	SJKS113-1xGH20	132		2 m	SJKS113-2xGH20	183
	SJKS113-1xGH25	144		2,5 m	SJKS113-2xGH25	195
	SJKS113-1xGH30	156		3 m	SJKS113-2xGH30	207
	SJKS113-1xGH35	168		3,5 m	SJKS113-2xGH35	219
	SJKS113-1xGH40	180		4 m	SJKS113-2xGH40	231

GRADE 80

... met haakklep / avec crochet avec linguet / with clevis latchhook



8mm

Code	Bruto €	Omschrijving / Description / Description	L	Code	Bruto €
SJKS108-1xHK10	49	8 mm WLL/CMU kg 4000daN	1 m	SJKS108-2xHK10	56
SJKS108-1xHK15	54		1,5 m	SJKS108-2xHK15	61
SJKS108-1xHK20	59		2 m	SJKS108-2xHK20	66
SJKS108-1xHK25	64		2,5 m	SJKS108-2xHK25	71
SJKS108-1xHK30	69		3 m	SJKS108-2xHK30	76
SJKS108-1xHK35	74		3,5 m	SJKS108-2xHK35	81
SJKS108-1xHK40	79		4 m	SJKS108-2xHK40	86



10mm

Code	Bruto €	Omschrijving / Description / Description	L	Code	Bruto €
SJKS110-1xHK10	62	10 mm WLL/CMU kg 6300daN	1 m	SJKS110-2xHK10	78
SJKS110-1xHK15	69		1,5 m	SJKS110-2xHK15	85
SJKS110-1xHK20	76		2 m	SJKS110-2xHK20	92
SJKS110-1xHK25	83		2,5 m	SJKS110-2xHK25	99
SJKS110-1xHK30	90		3 m	SJKS110-2xHK30	106
SJKS110-1xHK35	97		3,5 m	SJKS110-2xHK35	113
SJKS110-1xHK40	104		4 m	SJKS110-2xHK40	120



13mm

Code	Bruto €	Omschrijving / Description / Description	L	Code	Bruto €
SJKS113-1xHK10	77	13 mm WLL/CMU kg 10600daN	1 m	SJKS113-2xHK10	98
SJKS113-1xHK15	89		1,5 m	SJKS113-2xHK15	110
SJKS113-1xHK20	101		2 m	SJKS113-2xHK20	122
SJKS113-1xHK25	113		2,5 m	SJKS113-2xHK25	134
SJKS113-1xHK30	125		3 m	SJKS113-2xHK30	146
SJKS113-1xHK35	137		3,5 m	SJKS113-2xHK35	158
SJKS113-1xHK40	149		4 m	SJKS113-2xHK40	170



GRADE 80

... met veiligheidshaak / avec crochet à verrouillage / with clevis safety hook

	Code	Bruto €	Omschrijving / Description / Description	L	Code	Bruto €
	SJKS108-1xGVH10	59	8 mm WLL/CMU kg 4000daN	1 m	SJKS108-2xGVH10	76
	SJKS108-1xGVH15	64		1,5 m	SJKS108-2xGVH15	81
	SJKS108-1xGVH20	69		2 m	SJKS108-2xGVH20	86
	SJKS108-1xGVH25	74		2,5 m	SJKS108-2xGVH25	91
	SJKS108-1xGVH30	79		3 m	SJKS108-2xGVH30	96
	SJKS108-1xGVH35	84		3,5 m	SJKS108-2xGVH35	101
	SJKS108-1xGVH40	89		4 m	SJKS108-2xGVH40	106



	Code	Bruto €	Omschrijving / Description / Description	L	Code	Bruto €
	SJKS110-1xGVH10	76	10 mm WLL/CMU kg 6300daN	1 m	SJKS110-2xGVH10	107
	SJKS110-1xGVH15	83		1,5 m	SJKS110-2xGVH15	114
	SJKS110-1xGVH20	90		2 m	SJKS110-2xGVH20	121
	SJKS110-1xGVH25	97		2,5 m	SJKS110-2xGVH25	128
	SJKS110-1xGVH30	104		3 m	SJKS110-2xGVH30	135
	SJKS110-1xGVH35	111		3,5 m	SJKS110-2xGVH35	142
	SJKS110-1xGVH40	118		4 m	SJKS110-2xGVH40	149



	Code	Bruto €	Omschrijving / Description / Description	L	Code	Bruto €
	SJKS113-1xGVH10	113	13 mm WLL/CMU kg 10600daN	1 m	SJKS113-2xGVH10	170
	SJKS113-1xGVH15	125		1,5 m	SJKS113-2xGVH15	182
	SJKS113-1xGVH20	137		2 m	SJKS113-2xGVH20	194
	SJKS113-1xGVH25	149		2,5 m	SJKS113-2xGVH25	206
	SJKS113-1xGVH30	161		3 m	SJKS113-2xGVH30	218
	SJKS113-1xGVH35	173		3,5 m	SJKS113-2xGVH35	230
	SJKS113-1xGVH40	185		4 m	SJKS113-2xGVH40	242



Hoogwaardige hijsketting – Chaîne à haute résistance – Chain high resistance



Code	Ø	WLL/CMU kg	Bruto €	EAN CODE
KELKGR806	6 mm	1100	7,10	
KELKGR808	8 mm	2000	10,10	
KELKGR810	10 mm	3250	14,85	
KELKGR813	13 mm	5300	24,63	
KELKGR816	16 mm	8000	41,48	
KELKGR818	18 mm	10000	56,16	
KELKGR820	20 mm	12000	70,41	
KELKGR822	22 mm	15000	88,90	

Gaffelhaken met klep – Crochets à chape à linguet – Clevis sling hooks



Code	Ø	WLL/CMU kg	Bruto €	EAN CODE
KMGHK06	6 mm	1120	5,80	
KMGHK0708	7-8 mm	2000	7,84	
KMGHK10	10 mm	3150	15,81	
KMGHK13	13 mm	5300	21,23	
KMGHK16	16 mm	8000	58,00	
KMGHK1820	18-20 mm	12500	92,25	
KMGHK22	22 mm	15500	283,84	

Gaffelveiligheidshaken – Crochets de sécurité à chape – Clevis type autolock safety hooks



Code	Ø	WLL/CMU kg	Bruto €	EAN CODE
KMGVH06	6 mm	1120	13,92	
KMGVH0708	7-8 mm	2000	17,15	
KMGVH10	10 mm	3150	30,95	
KMGVH13	13 mm	5300	56,84	
KMGVH16	16 mm	8000	148,39	
KMGVH1820	18-20 mm	12500	157,00	
KMGVH22	22 mm	15500	313,00	

Ooghaken met klep – Crochets à oeil à linguet – Eye sling hooks



Code	Ø	WLL/CMU kg	Bruto €	EAN CODE
KMOHK06	6 mm	1120	6,85	
KMOHK0708	7-8 mm	2000	10,04	
KMOHK10	10 mm	3150	17,56	
KMOHK13	13 mm	5300	31,02	
KMOHK16	16 mm	8000	48,75	
KMOHK1820	20 mm	12500	96,96	
KMOHK22	22 mm	15500	283,84	

Oogveiligheidshaken – Crochets de sécurité à oeil – Eye autolock hooks



Code	Ø	WLL/CMU kg	Bruto €	EAN CODE
KMOVH06	6 mm	1120	17,73	
KMOVH0708	7-8 mm	2000	22,60	
KMOVH10	10 mm	3150	34,09	
KMOVH13	13 mm	5300	60,47	
KMOVH16	16 mm	8000	123,00	
KMOVH20	20 mm	12500	199,19	
KMOVH22	22 mm	15500	311,00	

Gaffelinkorthaken - Crochets de raccourcissement à chape - Clevis grab hooks with wing



Code	Ø	WLL/CMU kg	Bruto €	EAN CODE
KMGIH06	6 mm	1120	3,97	
KMGIH0708	7-8 mm	2000	5,75	
KMGIH10	10 mm	3150	11,00	
KMGIH13	13 mm	5300	22,53	
KMGIH16	16 mm	8000	37,70	
KMGIH1820	20 mm	12500	65,52	
KMGIH22	22 mm	15500	112,63	

Ooginkorthaken – Crochets de raccourcissement à oeil – Eye grab hooks with wing



Code	Ø	WLL/CMU kg	Bruto €	EAN CODE
KMOIH06	6 mm	1120	3,97	
KMOIH0708	7-8 mm	2000	5,85	
KMOIH10	10 mm	3150	12,25	
KMOIH13	13 mm	5300	23,60	
KMOIH16	16 mm	8000	40,43	
KMOIH20	20 mm	12500	76,48	
KMOIH22	22 mm	15500	131,60	

Gieterijhaken - Crochet de fonderie - Foundry hook



Code	Ø	WLL/CMU kg	Bruto €	EAN CODE
KMGH08	8 mm	2000	11,58	
KMGH10	10 mm	3150	20,43	
KMGH13	13 mm	5300	34,99	
KMGH16	16 mm	8000	65,20	
KMGH18	18 mm	11000	On request	
KMGH22	22 mm	11500	On request	

Verbindingsschalmen – Mailles d'accouplement – Alloy connection links



Code	Ø	WLL/CMU kg	Bruto €	EAN CODE
KMVS06	6 mm	1120	6,05	
KMVS0708	7-8 mm	2000	8,25	
KMVS10	10 mm	3150	9,50	
KMVS13	13 mm	5300	16,55	
KMVS16	16 mm	8000	25,65	
KMVS1820	18-20 mm	12500	38,67	
KMVS22	22 mm	15000	53,00	
KMVS2426	24 - 26 mm	21200	On request	
KMVS3032	30- 32 mm	31500	On request	

**Topschalmen voor kettingleng- Mailles de tête simple pour élingues à 1 brin
Master links for chain with 1 strand**



Code	Ø	WLL/CMU kg	Bruto €	EAN CODE
KMERIH06	6 mm	1400	14,35	
KMERIH08	8 mm	2500	27,14	
KMERIH10	10 mm	4000	41,90	
KMERIH13	13 mm	6700	84,68	

Geïntegreerde inkorthaken - Crochets de raccourcissement intégré - Integrated shortening hooks

**Topschalmen voor 2-sprong - Mailles de tête simple pour élingues à 2 brins
Master links for chain with 2 strands**



Code	Ø	WLL/CMU kg	Bruto €	EAN CODE
KMER2IH06	6 mm	2000	23,80	
KMER2IH08	8 mm	2500	41,40	
KMER2IH10	10 mm	4000	68,60	
KMER2IH13	13 mm	6700	121,28	

Geïntegreerde inkorthaken - Crochets de raccourcissement intégré - Integrated shortening hooks

**Topschalmen 4-sprong - Mailles de tête simple pour élingues à 4 brins
Master links for chain with 4 strands**



Code	Ø	WLL/CMU kg	Bruto €	EAN CODE
KMER4IH06	6 mm	3000	50,57	
KMER4IH08	8 mm	5300	97,44	
KMER4IH10	10 mm	8000	145,05	
KMER4IH13	13 mm	14000	280,90	

Geïntegreerde inkorthaken - Crochets de raccourcissement intégré - Integrated shortening hooks



NIEUW
NOUVEAU
NEW

Geïntegreerd inkortsysteem
Système de raccourcissement intégré
Integrated shortening system



NIEUW
NOUVEAU
NEW

Geïntegreerd inkortsysteem
Système de raccourcissement intégré
Integrated shortening system

GRADE 80



Regulier inkortsysteem
Système de raccourcissement ordinaire
Regular shortening system



Omegasluitingen - Mailles omega - Omega links



Code	Ø	WLL/CMU kg	Bruto €	EAN CODE
KMOS0506	5-6 mm	1000	6,05	
KMOS0708	7-8 mm	2000	8,25	
KMOS10	10 mm	3200	9,50	
KMOS13	13 mm	5100	16,55	
KMOS16	16 mm	8000	25,65	
KMOS20	20 mm	12500	On request	

Topschalen voor kettingleng en 2-sprong - Mailles de tête simple pour élingues à 1 et 2 brins - Master links for chain with 1 or 2 strands



Code	Ø	WLL/CMU kg	Bruto €	EAN CODE
KMER0706	7 mm(1), 6 mm(2)	1600	4,42	
KMER0807	8 mm(1), 7 mm(2)	2000	6,55	
KMER1008	10 mm(1), 8 mm(2)	3150	10,97	
KMER1310	13 mm(1), 10 mm(2)	5300	17,68	
KMER1613	16 mm(1), 13 mm(2)	8000	44,20	
KMER18	18 mm	12500	62,40	
KMER2016	20 mm(1), 16 mm(2)	15000	80,20	
KMER2220	22 mm(1), 20 mm(2)	17000	177,84	

Topschalen voor ketting 3 en 4-sprong - Mailles de tête double pour élingues à 3 et 4 brins - Master links for chain with 3 or 4 strands



Code	Ø	WLL/CMU kg	Bruto €	EAN CODE
KMDR06	6 mm	2360	16,09	
KMDR0708	7-8 mm	4250	29,82	
KMDR10	10 mm	6700	38,25	
KMDR13	13 mm	11200	83,00	
KMDR16	16 mm	17000	121,45	
KMDR18	18 mm	24800	275,00	
KMDR20	20 mm	26500	262,00	
KMDR22	22 mm	31500	342,00	

Wartelhaken met klep – Crochets à émerillon avec linguet – Swivel hooks with latch



Code	Ø	WLL/CMU kg	Bruto €	EAN CODE
KMWHK012	6 mm	1120	21,09	
KMWHK025	8 mm	2000	23,57	
KMWHK032	10 mm	3150	52,90	
KMWHK054	13 mm	5300	90,55	
KMWHK080	16 mm	8000	168,18	
KMWHK115	18 mm	12500	333,24	
KMWHK150	20 mm	15000	450,80	

Wartelveiligheidshaken – Crochet de sécurité à émerillon – Clevis type autolock hooks



Code	Ø	WLL/CMU kg	Bruto €	EAN CODE
KMWHVK012	6 mm	1120	36,77	
KMWHVK020	7-8 mm	2000	47,53	
KMWHVK032	10 mm	3150	84,65	
KMWHVK054	13 mm	5300	169,50	
KMWHVK082	16 mm	8000	336,55	
KMWHVK125	18 mm	12500	327,00	
KMWHVK150	20 mm	15000	583,89	
KMWHVK210	22 mm	21200	987,59	
KMWHVK320	26 mm	31500	1945,26	

Ratelvrachtspanners - Tendeurs d'arrimage pour chaîne – Load binders with ratchet and hook



Code	Ø	WLL/CMU kg	Bruto €	EAN CODE
KMRS08	8 mm	2450	41,00	
KMRS10	10 mm	4175	50,00	
KMRS13	13 mm	5900	87,00	

Aanlashedaken – Crochets de levage à souder - Weld on hooks



Code	WLL/CMU kg	Bruto €	EAN CODE
KMAH20	2000	16,27	
KMAH30	3000	20,50	
KMAH50	5000	43,30	
KMAH80	8000	55,35	
KMAH100	10000	88,35	

Aanlasogen – Oeillets à souder – Forged D rings with lash



Code	WLL/CMU kg	Bruto €	EAN CODE
KMAO020	2000	8,95	
KMAO030	3000	11,97	
KMAO050	5000	26,27	
KMAO080	8000	43,80	
KMAO150	15000	120,20	

**Ring/oog om aan een constructie vast te bouten "aanlasoog" met bevestigingsplaat - Oeil de soudeur avec plaque de montage
Weld-on D-rings plate mounted**



Code	Ø	WLL/CMU kg	Bruto €	EAN CODE
KMAOBM01	M12 x 18 mm	500	21,00	
KMAOBM02	M16 x 29,5 mm	1250	25,00	
KMAOBM03	M20 x 29,5 mm	2000	31,00	
KMAOBM05	M24 x 29,5 mm	3200	53,00	
KMAOBM08	M30 x 35 mm	5000	85,00	

C-haken - Crochets modèle C - C hooks



Code	Ø	WLL/CMU kg	Bruto €	EAN CODE
KMCH07	7-8 mm	2000	10,80	
KMCH10	10 mm	3150	22,60	
KMCH13	13 mm	5300	38,00	

Glijhaak - Crochet coulissant - Sliding hook



Code	Ø	WLL/CMU kg	Bruto €	EAN CODE
KMKAGH1013	10 - 14mm	2000	On request	
KMKAGH16	10 -16mm	3150	On request	
KMKAGH19	10 - 19mm	5300	On request	

Kogelkophaak - Crochet à tête sphérique - Ball head hook concrete



Code	WLL/CMU kg	Bruto €	EAN CODE
KMKKOP13	1300	52,00	
KMKKOP25	2500	59,00	
KMKKOP50	5000	86,00	
KMKKOP100	10000	225,00	
KMKKOP200	20000	486,00	

Containerhaken - Crochets pour Container - Container lifting hooks



Code	WLL/CMU kg	Bruto €	EAN CODE
KMCHS12T	12000	107,00	

ID Plaatjes - Placques d'identification - ID Plates

Code	Omschrijving / Description	Bruto €	
IDKM	ID RVS + label locker 40 x 55mm	4,50	
IDKMGRAF	ID RVS + label locker gegraveerd/gravé/engraved	8,00	
IDAM1	Alu. label + kabel/cable 55 x 55mm	4,50	
IDAM3	Alu. label + kabel/cable 35 x 55mm	4,50	

Oogbouten - Boulons à oeuil - Eye bolts



Code	Draad/Thread	WLL/CMU kg	Bruto €	EAN CODE
KMOBM06	M6	400	3,00	
KMOBM08	M8	800	3,90	
KMOBM10	M10	1000	7,08	
KMOBM12	M12	2000	8,85	
KMOBM14	M14	3000	11,00	
KMOBM16	M16	4000	12,75	
KMOBM20	M20	6000	19,60	
KMOBM24	M24	8000	27,87	
KMOBM30	M30	12000	43,00	
KMOBM36	M36	16000	78,00	
KMOBM42	M42	24000	104,93	
KMOBM48	M48	32000	179,10	

Oogmoeren - écrou à oeil - Eye nut



Code	Draad/Thread	WLL/CMU kg	Bruto €	EAN CODE
KMOMM06	M6	400	3,10	
KMOMM08	M8	800	3,20	
KMOMM10	M10	1000	5,60	
KMOMM12	M12	2000	8,30	
KMOMM14	M14	3000	10,26	
KMOMM16	M16	4000	12,54	
KMOMM20	M20	6000	17,10	
KMOMM24	M24	8000	23,94	
KMOMM30	M30	12000	38,76	
KMOMM36	M36	16000	61,56	
KMOMM42	M42	24000	91,20	
KMOMM48	M48	32000	137,30	

Wartelooqbouten op lager 90° – Oeillets de levage à emerillon 90° - Multi directional lifting swivels 90°



Code	Ø	WLL/CMU kg	Bruto €	EAN CODE
KMSW005	M12 x 18 mm	500 kg	30,25	
KMSW125	M16 x 29,5 mm	1250 kg	32,60	
KMSW200	M20 x 29,5 mm	2000 kg	47,00	
KMSW320	M24 x 29,5 mm	3200 kg	63,84	
KMSW500	M30 x 35 mm	5000 kg	117,00	
KMSW800	M30 x 35 mm	8000 kg	159,60	

Welfselhaken – Crochets hourdis – Vault hooks



Code	WLL/CMU kg	Bruto €	EAN CODE
HADAL100	1000 kg	78,00	

Klepkit voor haak met klep – Kit à linguet pour crochet à linguet – Kit for clevis sling hook



Code	voor ketting Ø / pour chaîne Ø / for chain Ø GRADE 80	Bruto €	EAN CODE
KMKLEP06	6 mm	5,00	
KMKLEP07	7-8 mm	5,50	
KMKLEP10	10 mm	6,00	
KMKLEP13	13 mm	8,00	
KMKLEP16	16mm	9,25	
KMKLEP20	20mm	15,00	
KMKLEP22	22mm	17,25	

Kit ontgrendelpal voor veiligheidshaak - Kit d'arrêt pour crochet de sécurité - Unbolt kit for safety hook



Code	voor ketting Ø / pour chaîne Ø / for chain Ø GRADE 80	Bruto €	EAN CODE
ODKMOP06	6 mm	9,00	
ODKMOP0708	7-8 mm	10,00	
ODKMOP10	10 mm	11,00	
ODKMOP13	13 mm	12,00	
ODKMOP16	16mm	16,00	
ODKMOP20	20mm	17,00	
ODKMOP22	22mm	18,00	

7 Kettingmateriaal - Accessoires de chaînes - Accessories for chain GRADE 100

Hoogwaardige hijsketting – Chaîne à haute résistance – Chain high resistance



Code	Ø	WLL/CMU kg	Bruto €	EAN CODE
1KELK06	6 mm	1400	9,30	
1KELK08	8 mm	2500	16,86	
1KELK10	10 mm	4000	25,61	
1KELK13	13 mm	6700	38,31	

Gaffelhaken met klep – Crochets à chape à linguet – Clevis sling hooks



Code	Ø	WLL/CMU kg	Bruto €	EAN CODE
1KMGHK06	6 mm	1400	8,65	
1KMGHK08	8 mm	2500	14,55	
1KMGHK10	10 mm	4000	22,99	
1KMGHK13	13 mm	6700	39,78	

Gaffelveiligheidshaken – Crochets de sécurité à chape – Clevis type autolock safety hooks



Code	Ø	WLL/CMU kg	Bruto €	EAN CODE
1KMGVH06	6 mm	1400	19,76	
1KMGVH08	8 mm	2500	27,33	
1KMGVH10	10 mm	4000	37,44	
1KMGVH13	13 mm	6700	68,00	

Ooghaken met klep – Crochets à oeuil à linguet – Eye sling hooks



Code	Ø	WLL/CMU kg	Bruto €	EAN CODE
1KMOHK06	6 mm	1400	7,85	
1KMOHK08	8 mm	2500	13,35	
1KMOHK10	10 mm	4000	22,35	
1KMOHK13	13 mm	6700	40,46	

Oogveiligheidshaken – Crochets de sécurité à oeuil – Eye autolock hooks



Code	Ø	WLL/CMU kg	Bruto €	EAN CODE
1KMOVH06	6 mm	1400	18,85	
1KMOVH08	8 mm	2500	26,20	
1KMOVH10	10 mm	4000	39,15	
1KMOVH13	13 mm	6700	75,45	

Gaffelinkorthaken - Crochets de raccourcissement à chape - Clevis grab hooks with wing



Code	Ø	WLL/CMU kg	Bruto €	EAN CODE
1KMGIH06	6 mm	1400	6,55	
1KMGIH08	8 mm	2500	9,45	
1KMGIH10	10 mm	4000	21,30	
1KMGIH13	13 mm	6700	37,25	

Ooginkorthaken – Crochets de raccourcissement à oeuil – Eye grab hooks with wing



Code	Ø	WLL/CMU kg	Bruto €	EAN CODE
1KMOIH06	6 mm	1400	7,45	
1KMOIH08	8 mm	2500	14,15	
1KMOIH10	10 mm	4000	24,85	
1KMOIH13	13 mm	6700	44,15	

Verbindingsschalen – Mailles d'accouplement – Alloy connection links



Code	Ø	WLL/CMU kg	Bruto €	EAN CODE
1KMVS06	6 mm	1400	6,17	
1KMVS08	8 mm	2500	9,20	
1KMVS10	10 mm	4000	11,73	
1KMVS13	13 mm	6700	19,50	

**Topschalmen voor kettingleng en 2-sprong - Mailles de tête simple pour élingues à 1 et 2 brins
Master links for chain with 1 or 2 strands**



Code	Ø	WLL/CMU kg	Bruto €	EAN CODE
1KMER0706	6 mm	1400	8,30	
1KMER08	8 mm	2500	11,85	
1KMER0810	10 mm	4000	13,95	
1KMER1013	13 mm	7500	28,56	
1KMER1316	16 mm	12500	46,00	

**Topschalmen voor 3- en 4-sprong - Mailles de tête simple pour élingues à 3 et 4 brins
Master links for chain with 3 or 4 strands**



Code	Ø	WLL/CMU kg	Bruto €	EAN CODE
1KMDR06	6 mm	3000	26,45	
1KMDR08	8 mm	5300	39,10	
1KMDR10	10 mm	8000	59,85	
1KMDR13	13 mm	14000	108,33	

**Topschalmen voor kettingleng- Mailles de tête simple pour élingues à 1 brin
Master links for chain with 1 strand**



Code	Ø	WLL/CMU kg	Bruto €	EAN CODE
1KMERIH06	6 mm	1400	20,48	
1KMERIH08	8 mm	2500	33,60	
1KMERIH10	10 mm	4000	43,68	
1KMERIH13	13 mm	6700	85,18	

Geïntegreerde inkorthaken - Crochets de raccourcissement intégré - Integrated shortening hooks

**Topschalmen voor 2-sprong - Mailles de tête simple pour élingues à 2 brins
Master links for chain with 2 strands**



Code	Ø	WLL/CMU kg	Bruto €	EAN CODE
1KMER2IH06	6 mm	2000	23,90	
1KMER2IH08	8 mm	2500	54,62	
1KMER2IH10	10 mm	4000	70,72	
1KMER2IH13	13 mm	6700	128,96	

Geïntegreerde inkorthaken - Crochets de raccourcissement intégré - Integrated shortening hooks

**Topschalmen 4-sprong - Mailles de tête simple pour élingues à 4 brins
Master links for chain with 4 strands**



Code	Ø	WLL/CMU kg	Bruto €	EAN CODE
1KMER4IH06	6 mm	3000	79,55	
1KMER4IH08	8 mm	5300	122,00	
1KMER4IH10	10 mm	8000	154,70	
1KMER4IH13	13 mm	14000	296,61	

Geïntegreerde inkorthaken - Crochets de raccourcissement intégré - Integrated shortening hooks



NIEUW
NOUVEAU
NEW

Geïntegreerd inkortsysteem
Système de raccourcissement intégré
Integrated shortening system



NIEUW
NOUVEAU
NEW

Geïntegreerd inkortsysteem
Système de raccourcissement intégré
Integrated shortening system



Regulier inkortsysteem
Système de raccourcissement ordinaire
Regular shortening system



Hoogwaardige DEE sluitingen met borstbout - Manilles droite haute résistance vissée
High resistance DEE shackles with screw pin



Code	Ø pin / Ø cheville	WLL/CMU kg	Bruto €	EAN CODE	
DSBB00050	8 mm (1/4")	500	1,76		
DSBB00075	10 mm (5/16")	750	1,92		
DSBB00100	12 mm (3/8")	1.000	2,68		
DSBB00150	14 mm (7/16")	1.500	3,54		
DSBB00200	16 mm (1/2")	2000	4,50		
DSBB00325	20 mm (5/8")	3250	7,82		
DSBB00475	22 mm (3/4")	4.750	11,24		
DSBB00650	27 mm (7/8")	6.500	15,93		
DSBB00850	30 mm (1")	8500	22,82		
DSBB00950	33 mm (1-1/8")	9500	32,40		
DSBB01200	36 mm (1-1/4")	12.000	45,17		
DSBB01350	39 mm (1-3/8")	13.500	57,06		
DSBB01700	42 mm (1-1/2")	17000	72,62		
DSBB02500	52 mm (1-3/4")	25000	139,31		
DSBB03500	60 mm (2")	35.000	222,30		
DSBB05500	72 mm (2-1/2")	55.000	404,59		

Hoogwaardige DEE sluitingen met bout en moer - Manilles droite haute résistance boulonnée goupillée
High resistance DEE shackles with safety pin



Code	Ø pin / Ø cheville	WLL/CMU kg	Bruto €	EAN CODE	
DSBM00050	8 mm (1/4")	500	2,00		
DSBM00075	10 mm (5/16")	750	2,33		
DSBM00100	12 mm (3/8")	1.000	3,16		
DSBM00150	14 mm (7/16")	1.500	4,31		
DSBM00200	16 mm (1/2")	2000	5,20		
DSBM00325	20 mm (5/8")	3250	8,52		
DSBM00475	22 mm (3/4")	4.750	12,67		
DSBM00650	27 mm (7/8")	6.500	18,19		
DSBM00850	30 mm (1")	8500	26,11		
DSBM00950	33 mm (1-1/8")	9500	36,39		
DSBM01200	36 mm (1-1/4")	12.000	57,14		
DSBM01350	39 mm (1-3/8")	13.500	63,73		
DSBM01700	42 mm (1-1/2")	17000	82,99		
DSBM02500	52 mm (1-3/4")	25000	174,14		
DSBM03500	60 mm (2")	35.000	244,53		
DSBM05500	72 mm (2-1/2")	55.000	490,54		

Hoogwaardige harpsluitingen met borstbout - Manilles de lyre haute résistance vissée
High resistance bow shackles with screw pin



Code	Ø pin / Ø cheville	WLL/CMU kg	Bruto €	EAN CODE	
HSBB00050	8 mm (1/4")	500	1,76		
HSBB00075	10 mm (5/16")	750	1,92		
HSBB00100	12 mm (3/8")	1.000	2,71		
HSBB00150	14 mm (7/16")	1.500	3,54		
HSBB00200	16 mm (1/2")	2000	4,70		
HSBB00325	20 mm (5/8")	3250	7,98		
HSBB00475	22 mm (3/4")	4.750	11,40		
HSBB00650	27 mm (7/8")	6.500	16,28		
HSBB00850	30 mm (1")	8500	23,30		
HSBB00950	33 mm (1-1/8")	9500	34,95		
HSBB01200	36 mm (1-1/4")	12.000	49,16		
HSBB01350	39 mm (1-3/8")	13.500	63,28		
HSBB01700	42 mm (1-1/2")	17000	80,03		
HSBB02500	52 mm (1-3/4")	25000	143,75		
HSBB03500	60 mm (2")	35.000	232,08		
HSBB05500	72 mm (2-1/2")	55.000	468,31		

Hoogwaardige harpsluitingen met bout en moer - Manille de lyre haute résistance boulonnée et goupillée
High resistance bow shackles with safety pin









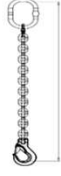

Code	Ø pin / Ø cheville	WLL/CMU kg	Bruto €	EAN CODE
HSBM00050	8 mm (1/4")	500	2,00	
HSBM00075	10 mm (5/16")	750	2,49	
HSBM00100	12 mm (3/8")	1.000	3,29	
HSBM00150	14 mm (7/16")	1.500	4,56	
HSBM00200	16 mm (1/2")	2000	6,20	
HSBM00325	20 mm (5/8")	3250	8,81	
HSBM00475	22 mm (3/4")	4.750	13,02	
HSBM00650	27 mm (7/8")	6.500	18,51	
HSBM00850	30 mm (1")	8500	26,33	
HSBM00950	33 mm (1-1/8")	9500	37,19	
HSBM01200	36 mm (1-1/4")	12.000	57,46	
HSBM01350	39 mm (1-3/8")	13.500	65,74	
HSBM01700	42 mm (1-1/2")	17000	88,92	
HSBM02500	52 mm (1-3/4")	25000	174,88	
HSBM03500	60 mm (2")	35.000	248,98	
HSBM05500	72 mm (2-1/2")	55.000	514,25	

Tabel - Tableau - Table GRADE 80

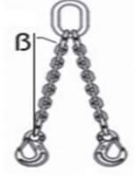
De genoemde lastcapaciteiten zijn maximale waarden van de getoonde hijsmethodes.

Les capacités de charge indiquées sont les valeurs maximales des méthodes de levage indiquées.

The given load capacities are maximum values of the given lifting method







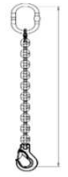

Type	leng 1 brin 1 leg		2-parten 2 brins 2 legged				3-4 parten 3-4 brins 3-4 legged		Strop Coulant Choked	Loop Loop Loop	
											
β °	–	–	till 45°	45°-60°	till 45°	45°-60°	till 45°	45°-60°		till 45°	45°-60°
Load factor	1	0,8	1,4	1	1,12	0,8	2,1	1,5	1,6	1,4	2,1
Grade Ø	W.L.L. (kg)										
80 / 6 mm	1.120	896	1.568	1.120	1.254	896	2.352	1.680	1.792	1.568	2.352
80 / 7 mm	1.500	1.200	2.100	1.500	1.680	1.200	3.150	2.250	2.400	2.100	3.150
80 / 8 mm	2.000	1.600	2.800	2.000	2.240	1.600	4.200	3.000	3.200	2.800	4.200
80 / 10 mm	3.150	2.520	4.410	3.150	3.528	2.520	6.615	4.725	5.040	4.410	6.615
80 / 13 mm	5.300	4.240	7.420	5.300	5.936	4.240	11.130	7.950	8.480	7.420	11.130
80 / 16 mm	8.000	6.400	11.200	8.000	8.960	6.400	16.800	12.000	12.800	11.200	16.800
80 / 18 mm	11.200	8.960	15.680	11.200	12.544	8.960	23.520	16.800	17.920	15.680	23.520
80 / 20 mm	12.500	10.000	17.500	12.500	14.000	10.000	26.250	18.750	20.000	17.500	26.250
80 / 22 mm	15.000	12.000	21.000	15.000	16.800	12.000	31.500	22.500	24.000	21.000	31.500
80 / 26 mm	21.200	16.960	29.680	21.200	23.744	16.960	44.520	31.800	33.920	29.680	44.520
80 / 32 mm	31.500	25.200	44.100	31.500	35.280	25.200	66.150	47.250	50.400	44.100	66.150

Tabel - Tableau - Table GRADE 100

De genoemde lastcapaciteiten zijn maximale waarden van de getoonde hijsmethodes.

Les capacités de charge indiquées sont les valeurs maximales des méthodes de levage indiquées.

The given load capacities are maximum values of the given lifting method

Type	leng		2-parten				3-4 parten		Strop	Loop	
	1 brin		2 brins		3-4 brins		3-4 legged		Coulant	Loop	
	1 leg		2 legged						Choked	Loop	
Figure											
β °	–	–	till 45°	45°-60°	till 45°	45°-60°	till 45°	45°-60°		till 45°	45°-60°
Load factor	1	0,8	1,4	1	1,12	0,8	2,1	1,5	1,6	1,4	2,1
Grade Ø	W.L.L. (kg)										
100 / 6 mm	1.500	1.200	2.100	1.500	1.680	1.200	3.150	2.250	2.400	2.100	3.150
100 / 8 mm	2.500	2.000	3.500	2.500	2.800	2.000	5.250	3.750	4.000	3.500	5.250
100 / 10 mm	4.000	3.200	5.600	4.000	4.480	3.200	8.400	6.000	6.400	5.600	8.400
100 / 13 mm	6.700	5.360	9.380	6.700	7.504	5.360	14.070	10.050	10.720	9.380	14.070
100 / 16 mm	10.000	8.000	14.000	10.000	11.200	8.000	21.000	15.000	16.000	14.000	21.000
100 / 18 mm	12.500	10.000	17.500	12.500	14.000	10.000	26.250	18.750	20.000	17.500	26.250
100 / 20 mm	16.000	12.800	22.400	16.000	17.920	12.800	33.600	24.000	25.600	22.400	33.600
100 / 22 mm	19.500	15.600	27.300	19.500	21.840	15.600	40.950	29.250	31.200	27.300	40.950
100 / 26 mm	26.500	21.200	37.100	26.500	29.680	21.200	55.650	39.750	42.400	37.100	55.650

**Standaard catalogus kettingsamenstellingen :
Assemblages de chaînes de catalogue standard :
Standard catalogue lifting chain assemblies :**

GRADE 80 & GRADE 100

**Gaffelhaak met klep
Crochet à chape à linguet
Clevis sling hook with latch**

**Gaffelveiligheidschaak
Crochet de sécurité à chape
Clevis type autolock safety hook**



Optioneel voor alle samenstellingen:
Facultatif pour toutes les compositions:
Optional for all chain assemblies:

**Inkorthaak
Crochet de raccourcissement
Clevis grab hook (shortener)**



In andere uitvoeringen verkrijgbaar. Prijzen steeds verkrijgbaar op aanvraag!
Variété de compositions disponible. Prix toujours disponible sur demande!
Various assemblies available. Price always available on request!

Grotere diameters steeds verkrijgbaar op aanvraag !
Des diamètres plus grands toujours disponibles sur demande !
Larger diameters always available on request !



**Grade 100 wordt standaard uitgerust met geïntegreerde inkorthaken.
Le grade 100 est équipé en standard avec de crochets de raccourcissement intégrés.
Grade 100 chain compositions are standard equipped with integrated shortening hooks.**



GRADE 80



	Code	L	Omschrijving / Description	Bruto €	EAN CODE
6mm	KS106HK10	1 m	Kettingleng Elingue à 1 brin Chain with 1 strand 6 mm WLL/CMU kg 1120 kg	41	...
	KS106HK15	1,5 m		44	...
	KS106HK20	2 m		47	...
	KS106HK25	2,5 m		50	...
	KS106HK30	3 m		53	...
	KS106HK35	3,5 m		56	...
	KS106HK40	4 m		59	...
	KS106HK45	4,5 m		62	...
	KS106HK50	5 m		65	...
	KS106HK55	5,5 m		68	...
	KS106HK60	6 m	71	...	



8mm	KS108HK10	1 m	Kettingleng Elingue à 1 brin Chain with 1 strand 8 mm WLL/CMU kg 2000 kg	50	...
	KS108HK15	1,5 m		54	...
	KS108HK20	2 m		58	...
	KS108HK25	2,5 m		62	...
	KS108HK30	3 m		66	...
	KS108HK35	3,5 m		70	...
	KS108HK40	4 m		74	...
	KS108HK45	4,5 m		78	...
	KS108HK50	5 m		82	...
	KS108HK55	5,5 m		86	...
	KS108HK60	6 m	90	...	



10 mm	KS110HK10	1 m	Kettingleng Elingue à 1 brin Chain with 1 strand 10 mm WLL/CMU kg 3200 kg	61	...
	KS110HK15	1,5 m		68	...
	KS110HK20	2 m		75	...
	KS110HK25	2,5 m		82	...
	KS110HK30	3 m		89	...
	KS110HK35	3,5 m		96	...
	KS110HK40	4 m		103	...
	KS110HK45	4,5 m		110	...
	KS110HK50	5 m		117	...
	KS110HK55	5,5 m		124	...
	KS110HK60	6 m	131	...	



13 mm	KS113HK10	1 m	Kettingleng Elingue à 1 brin Chain with 1 strand 13 mm WLL/CMU kg 5300 kg	74	...
	KS113HK15	1,5 m		86	...
	KS113HK20	2 m		98	...
	KS113HK25	2,5 m		110	...
	KS113HK30	3 m		122	...
	KS113HK35	3,5 m		134	...
	KS113HK40	4 m		146	...
	KS113HK45	4,5 m		158	...
	KS113HK50	5 m		170	...
	KS113HK55	5,5 m		182	...
	KS113HK60	6 m	194	...	

GRADE 100



	Code	L	Omschrijving / Description / Description	Bruto €	EAN CODE
6 mm	1KS106HK10	1 m	Kettingleng Elingue à 1 brin Chain with 1 strand 6 mm WLL/CMU kg 1500 kg	54	...
	1KS106HK15	1,5 m		59	...
	1KS106HK20	2 m		64	...
	1KS106HK25	2,5 m		69	...
	1KS106HK30	3 m		74	...
	1KS106HK35	3,5 m		79	...
	1KS106HK40	4 m		84	...
	1KS106HK45	4,5 m		89	...
	1KS106HK50	5 m		94	...
	1KS106HK55	5,5 m		99	...
	1KS106HK60	6 m	104	...	



8 mm	1KS108HK10	1 m	Kettingleng Elingue à 1 brin Chain with 1 strand 8 mm WLL/CMU kg 2500 kg	67	...
	1KS108HK15	1,5 m		74	...
	1KS108HK20	2 m		81	...
	1KS108HK25	2,5 m		88	...
	1KS108HK30	3 m		95	...
	1KS108HK35	3,5 m		102	...
	1KS108HK40	4 m		109	...
	1KS108HK45	4,5 m		116	...
	1KS108HK50	5 m		123	...
	1KS108HK55	5,5 m		130	...
	1KS108HK60	6 m	137	...	



10 mm	1KS110HK10	1 m	Kettingleng Elingue à 1 brin Chain with 1 strand 10 mm WLL/CMU kg 4000 kg	85	...
	1KS110HK15	1,5 m		96	...
	1KS110HK20	2 m		107	...
	1KS110HK25	2,5 m		118	...
	1KS110HK30	3 m		129	...
	1KS110HK35	3,5 m		140	...
	1KS110HK40	4 m		151	...
	1KS110HK45	4,5 m		162	...
	1KS110HK50	5 m		173	...
	1KS110HK55	5,5 m		184	...
	1KS110HK60	6 m	195	...	



13 mm	1KS113HK10	1 m	Kettingleng Elingue à 1 brin Chain with 1 strand 13 mm WLL/CMU kg 6700 kg	128	...
	1KS113HK15	1,5 m		147	...
	1KS113HK20	2 m		166	...
	1KS113HK25	2,5 m		185	...
	1KS113HK30	3 m		204	...
	1KS113HK35	3,5 m		223	...
	1KS113HK40	4 m		242	...
	1KS113HK45	4,5 m		261	...
	1KS113HK50	5 m		280	...
	1KS113HK55	5,5 m		299	...
	1KS113HK60	6 m	318	...	

GRADE 80



	Code	L	Omschrijving / Description / Description	Bruto €	EAN CODE
6 mm	KS206HK10	1 m	Ketting 2-sprong Elingue à 2 brins Chain with 2 strands 6 mm WLL/CMU kg <45° - 1600 kg 45° < 60° - 1120 kg	65	...
	KS206HK15	1,5 m		71	...
	KS206HK20	2 m		77	...
	KS206HK25	2,5 m		83	...
	KS206HK30	3 m		89	...
	KS206HK35	3,5 m		95	...
	KS206HK40	4 m		101	...
	KS206HK45	4,5 m		107	...
	KS206HK50	5 m		113	...
	KS206HK55	5,5 m		119	...
KS206HK60	6 m	125	...		



8 mm	KS208HK10	1 m	Ketting 2-sprong Elingue à 2 brins Chain with 2 strands 8 mm WLL/CMU kg <45° - 2800 kg 45° < 60° - 2000 kg	74	...
	KS208HK15	1,5 m		84	...
	KS208HK20	2 m		93	...
	KS208HK25	2,5 m		102	...
	KS208HK30	3 m		111	...
	KS208HK35	3,5 m		120	...
	KS208HK40	4 m		129	...
	KS208HK45	4,5 m		138	...
	KS208HK50	5 m		147	...
	KS208HK55	5,5 m		156	...
KS208HK60	6 m	165	...		



10 mm	KS210HK10	1 m	Ketting 2-sprong Elingue à 2 brins Chain with 2 strands 10 mm WLL/CMU kg <45° - 4400 kg 45° < 60° - 3200 kg	103	...
	KS210HK15	1,5 m		116	...
	KS210HK20	2 m		129	...
	KS210HK25	2,5 m		142	...
	KS210HK30	3 m		155	...
	KS210HK35	3,5 m		168	...
	KS210HK40	4 m		181	...
	KS210HK45	4,5 m		194	...
	KS210HK50	5 m		207	...
	KS210HK55	5,5 m		220	...
KS210HK60	6 m	233	...		



13 mm	KS213HK10	1 m	Ketting 2-sprong Elingue à 2 brins Chain with 2 strands 13 mm WLL/CMU kg <45° - 7400 kg 45° < 60° - 5300 kg	161	...
	KS213HK15	1,5 m		184	...
	KS213HK20	2 m		206	...
	KS213HK25	2,5 m		228	...
	KS213HK30	3 m		250	...
	KS213HK35	3,5 m		272	...
	KS213HK40	4 m		294	...
	KS213HK45	4,5 m		316	...
	KS213HK50	5 m		338	...
	KS213HK55	5,5 m		360	...
KS213HK60	6 m	382	...		

GRADE 100



	Code	L	Omschrijving / Description / Description	Bruto €	EAN CODE
6 mm	1KS206HK10	1 m	Ketting 2-sprong Elingue à 2 brins Chain with 2 strands 6 mm WLL/CMU kg <45° - 2100 kg 45° < 60° - 1500 kg	93	...
	1KS206HK15	1,5 m		103	...
	1KS206HK20	2 m		113	...
	1KS206HK25	2,5 m		123	...
	1KS206HK30	3 m		133	...
	1KS206HK35	3,5 m		143	...
	1KS206HK40	4 m		153	...
	1KS206HK45	4,5 m		163	...
	1KS206HK50	5 m		173	...
	1KS206HK55	5,5 m		183	...
	1KS206HK60	6 m	193	...	



8 mm	1KS208HK10	1 m	Ketting 2-sprong Elingue à 2 brins Chain with 2 strands 8 mm WLL/CMU kg <45° - 3500 kg 45° < 60° - 2500 kg	116	...
	1KS208HK15	1,5 m		130	...
	1KS208HK20	2 m		144	...
	1KS208HK25	2,5 m		158	...
	1KS208HK30	3 m		172	...
	1KS208HK35	3,5 m		186	...
	1KS208HK40	4 m		200	...
	1KS208HK45	4,5 m		214	...
	1KS208HK50	5 m		228	...
	1KS208HK55	5,5 m		242	...
	1KS208HK60	6 m	256	...	



10 mm	1KS210HK10	1 m	Ketting 2-sprong Elingue à 2 brins Chain with 2 strands 10 mm WLL/CMU kg <45° - 5600 kg 45° < 60° - 4000 kg	148	...
	1KS210HK15	1,5 m		170	...
	1KS210HK20	2 m		192	...
	1KS210HK25	2,5 m		214	...
	1KS210HK30	3 m		236	...
	1KS210HK35	3,5 m		258	...
	1KS210HK40	4 m		280	...
	1KS210HK45	4,5 m		302	...
	1KS210HK50	5 m		324	...
	1KS210HK55	5,5 m		346	...
	1KS210HK60	6 m	368	...	



13 mm	1KS213HK10	1 m	Ketting 2-sprong Elingue à 2 brins Chain with 2 strands 13 mm WLL/CMU kg <45° - 9400 kg 45° < 60° - 6700 kg	231	...
	1KS213HK15	1,5 m		264	...
	1KS213HK20	2 m		297	...
	1KS213HK25	2,5 m		330	...
	1KS213HK30	3 m		363	...
	1KS213HK35	3,5 m		396	...
	1KS213HK40	4 m		429	...
	1KS213HK45	4,5 m		462	...
	1KS213HK50	5 m		495	...
	1KS213HK55	5,5 m		528	...
	1KS213HK60	6 m	561	...	

... met gaffelhaak met klep / avec crochet à chape à linguet / with clevis sling hook with latch

GRADE 80



	Code	L	Omschrijving / Description / Description	Bruto €	EAN CODE
6 mm	KS406HK10	1 m	Ketting 4-sprong Elingue à 4 brins Chain with 4 strands 6 mm WLL/CMU kg < 45° - 2400 kg 45° < 60° - 1700 kg	97	...
	KS406HK15	1,5 m		110	...
	KS406HK20	2 m		123	...
	KS406HK25	2,5 m		136	...
	KS406HK30	3 m		149	...
	KS406HK35	3,5 m		162	...
	KS406HK40	4 m		175	...
	KS406HK45	4,5 m		188	...
	KS406HK50	5 m		201	...
	KS406HK55	5,5 m		214	...
KS406HK60	6 m	227	...		



8 mm	KS408HK10	1 m	Ketting 4-sprong Elingue à 4 brins Chain with 4 strands 8 mm WLL/CMU kg < 45° - 4200 kg 45° < 60° - 3000 kg	147	...
	KS408HK15	1,5 m		167	...
	KS408HK20	2 m		187	...
	KS408HK25	2,5 m		207	...
	KS408HK30	3 m		227	...
	KS408HK35	3,5 m		247	...
	KS408HK40	4 m		267	...
	KS408HK45	4,5 m		287	...
	KS408HK50	5 m		307	...
	KS408HK55	5,5 m		327	...
KS408HK60	6 m	347	...		



10 mm	KS410HK10	1 m	Ketting 4-sprong Elingue à 4 brins Chain with 4 strands 10 mm WLL/CMU kg < 45° - 6600 kg 45° < 60° - 4700 kg	174	...
	KS410HK15	1,5 m		201	...
	KS410HK20	2 m		228	...
	KS410HK25	2,5 m		255	...
	KS410HK30	3 m		282	...
	KS410HK35	3,5 m		309	...
	KS410HK40	4 m		336	...
	KS410HK45	4,5 m		363	...
	KS410HK50	5 m		390	...
	KS410HK55	5,5 m		417	...
KS410HK60	6 m	444	...		



13 mm	KS413HK10	1 m	Ketting 4-sprong Elingue à 4 brins Chain with 4 strands 13 mm WLL/CMU kg < 45° - 11100 kg 45° < 60° - 8000 kg	326	...
	KS413HK15	1,5 m		368	...
	KS413HK20	2 m		410	...
	KS413HK25	2,5 m		452	...
	KS413HK30	3 m		494	...
	KS413HK35	3,5 m		536	...
	KS413HK40	4 m		578	...
	KS413HK45	4,5 m		620	...
	KS413HK50	5 m		662	...
	KS413HK55	5,5 m		704	...
KS413HK60	6 m	746	...		

GRADE 100



6 mm

Code	L	Omschrijving / Description / Description	Bruto €	EAN CODE
1KS406HK10	1 m	Ketting 4-sprong Elingue à 4 brins Chain with 4 strands 6 mm WLL/CMU kg < 45° - 3200 kg 45° < 60° - 2300 kg	137	...
1KS406HK15	1,5 m		154	...
1KS406HK20	2 m		171	...
1KS406HK25	2,5 m		188	...
1KS406HK30	3 m		205	...
1KS406HK35	3,5 m		222	...
1KS406HK40	4 m		239	...
1KS406HK45	4,5 m		256	...
1KS406HK50	5 m		273	...
1KS406HK55	5,5 m		290	...
1KS406HK60	6 m	307	...	



8 mm

1KS408HK10	1 m	Ketting 4-sprong Elingue à 4 brins Chain with 4 strands 8 mm WLL/CMU kg < 45° - 5300 kg 45° < 60° - 3800 kg	193	...
1KS408HK15	1,5 m		216	...
1KS408HK20	2 m		239	...
1KS408HK25	2,5 m		262	...
1KS408HK30	3 m		285	...
1KS408HK35	3,5 m		308	...
1KS408HK40	4 m		331	...
1KS408HK45	4,5 m		354	...
1KS408HK50	5 m		377	...
1KS408HK55	5,5 m		400	...
1KS408HK60	6 m	423	...	



10 mm

1KS410HK10	1 m	Ketting 4-sprong Elingue à 4 brins Chain with 4 strands 10 mm WLL/CMU kg < 45° - 8400 kg 45° < 60° - 6000 kg	274	...
1KS410HK15	1,5 m		312	...
1KS410HK20	2 m		350	...
1KS410HK25	2,5 m		388	...
1KS410HK30	3 m		426	...
1KS410HK35	3,5 m		464	...
1KS410HK40	4 m		502	...
1KS410HK45	4,5 m		540	...
1KS410HK50	5 m		578	...
1KS410HK55	5,5 m		616	...
1KS410HK60	6 m	654	...	



13 mm

1KS413HK10	1 m	Ketting 4-sprong Elingue à 4 brins Chain with 4 strands 13 mm WLL/CMU kg < 45° - 14100 kg 45° < 60° - 11100 kg	440	...
1KS413HK15	1,5 m		498	...
1KS413HK20	2 m		556	...
1KS413HK25	2,5 m		614	...
1KS413HK30	3 m		672	...
1KS413HK35	3,5 m		730	...
1KS413HK40	4 m		788	...
1KS413HK45	4,5 m		846	...
1KS413HK50	5 m		904	...
1KS413HK55	5,5 m		962	...
1KS413HK60	6 m	1020	...	



... met gaffelhaak met klep + inkorthaak / avec crochet à chape à linguet + crochet de raccourcissement /
with clevis sling hook with latch + clevis grab hook with wing

GRADE 80



	Code	L	Omschrijving / Description / Description	Bruto €	EAN CODE
6 mm	KS106HKIH10	1 m	Kettingleng Elingue à 1 brin Chain with 1 strand 6 mm WLL/CMU kg 1120 kg	44	...
	KS106HKIH15	1,5 m		47	...
	KS106HKIH20	2 m		50	...
	KS106HKIH25	2,5 m		53	...
	KS106HKIH30	3 m		56	...
	KS106HKIH35	3,5 m		59	...
	KS106HKIH40	4 m		62	...
	KS106HKIH45	4,5 m		65	...
	KS106HKIH50	5 m		68	...
	KS106HKIH55	5,5 m		71	...
KS106HKIH60	6 m	74	...		



8 mm	KS108HKIH10	1 m	Kettingleng Elingue à 1 brin Chain with 1 strand 8 mm WLL/CMU kg 2000 kg	53	...
	KS108HKIH15	1,5 m		57	...
	KS108HKIH20	2 m		61	...
	KS108HKIH25	2,5 m		65	...
	KS108HKIH30	3 m		69	...
	KS108HKIH35	3,5 m		73	...
	KS108HKIH40	4 m		77	...
	KS108HKIH45	4,5 m		81	...
	KS108HKIH50	5 m		85	...
	KS108HKIH55	5,5 m		89	...
KS108HKIH60	6 m	93	...		



10 mm	KS110HKIH10	1 m	Kettingleng Elingue à 1 brin Chain with 1 strand 10 mm WLL/CMU kg 3200 kg	71	...
	KS110HKIH15	1,5 m		78	...
	KS110HKIH20	2 m		85	...
	KS110HKIH25	2,5 m		92	...
	KS110HKIH30	3 m		99	...
	KS110HKIH35	3,5 m		106	...
	KS110HKIH40	4 m		113	...
	KS110HKIH45	4,5 m		120	...
	KS110HKIH50	5 m		127	...
	KS110HKIH55	5,5 m		134	...
KS110HKIH60	6 m	141	...		



13 mm	KS113HKIH10	1 m	Kettingleng Elingue à 1 brin Chain with 1 strand 13 mm WLL/CMU kg 5300 kg	93	...
	KS113HKIH15	1,5 m		105	...
	KS113HKIH20	2 m		117	...
	KS113HKIH25	2,5 m		129	...
	KS113HKIH30	3 m		141	...
	KS113HKIH35	3,5 m		153	...
	KS113HKIH40	4 m		165	...
	KS113HKIH45	4,5 m		177	...
	KS113HKIH50	5 m		189	...
	KS113HKIH55	5,5 m		201	...
KS113HKIH60	6 m	213	...		

GRADE 100



	Code	L	Omschrijving / Description / Description	Bruto €	EAN CODE
6 mm	1KS106HKIH10	1 m	Kettingleng Elingue à 1 brin Chain with 1 strand 6 mm WLL/CMU kg 1500 kg	61	...
	1KS106HKIH15	1,5 m		66	...
	1KS106HKIH20	2 m		71	...
	1KS106HKIH25	2,5 m		76	...
	1KS106HKIH30	3 m		81	...
	1KS106HKIH35	3,5 m		86	...
	1KS106HKIH40	4 m		91	...
	1KS106HKIH45	4,5 m		96	...
	1KS106HKIH50	5 m		101	...
	1KS106HKIH55	5,5 m		106	...
	1KS106HKIH60	6 m	111	...	



8 mm	1KS108HKIH10	1 m	Kettingleng Elingue à 1 brin Chain with 1 strand 8 mm WLL/CMU kg 2500 kg	73	...
	1KS108HKIH15	1,5 m		80	...
	1KS108HKIH20	2 m		87	...
	1KS108HKIH25	2,5 m		94	...
	1KS108HKIH30	3 m		101	...
	1KS108HKIH35	3,5 m		108	...
	1KS108HKIH40	4 m		115	...
	1KS108HKIH45	4,5 m		122	...
	1KS108HKIH50	5 m		129	...
	1KS108HKIH55	5,5 m		136	...
	1KS108HKIH60	6 m	143	...	



10 mm	1KS110HKIH10	1 m	Kettingleng Elingue à 1 brin Chain with 1 strand 10 mm WLL/CMU kg 4000 kg	96	...
	1KS110HKIH15	1,5 m		107	...
	1KS110HKIH20	2 m		118	...
	1KS110HKIH25	2,5 m		129	...
	1KS110HKIH30	3 m		140	...
	1KS110HKIH35	3,5 m		151	...
	1KS110HKIH40	4 m		162	...
	1KS110HKIH45	4,5 m		173	...
	1KS110HKIH50	5 m		184	...
	1KS110HKIH55	5,5 m		195	...
	1KS110HKIH60	6 m	206	...	



13 mm	1KS113HKIH10	1 m	Kettingleng Elingue à 1 brin Chain with 1 strand 13 mm WLL/CMU kg 6700 kg	150	...
	1KS113HKIH15	1,5 m		169	...
	1KS113HKIH20	2 m		188	...
	1KS113HKIH25	2,5 m		207	...
	1KS113HKIH30	3 m		226	...
	1KS113HKIH35	3,5 m		245	...
	1KS113HKIH40	4 m		264	...
	1KS113HKIH45	4,5 m		283	...
	1KS113HKIH50	5 m		302	...
	1KS113HKIH55	5,5 m		321	...
	1KS113HKIH60	6 m	340	...	

... met gaffelhaak met klep + inkorthaak / avec crochet à chape à linguet + crochet de raccourcissement /
with clevis sling hook with latch + clevis grab hook with wing

GRADE 80



	Code	L	Omschrijving / Description / Description	Bruto €	EAN CODE
6 mm	KS206HKIH10	1 m	Ketting 2-sprong Elingue à 2 brins Chain with 2 strands 6 mm WLL/CMU kg <45° - 1600 kg 45° < 60° - 1120 kg	71,00	...
	KS206HKIH15	1,5 m		77,00	...
	KS206HKIH20	2 m		83,00	...
	KS206HKIH25	2,5 m		89,00	...
	KS206HKIH30	3 m		95,00	...
	KS206HKIH35	3,5 m		101,00	...
	KS206HKIH40	4 m		107,00	...
	KS206HKIH45	4,5 m		113,00	...
	KS206HKIH50	5 m		119,00	...
	KS206HKIH55	5,5 m		125,00	...
KS206HKIH60	6 m	131,00	...		



8 mm	KS208HKIH10	1 m	Ketting 2-sprong Elingue à 2 brins Chain with 2 strands 8 mm WLL/CMU kg <45° - 2800 kg 45° < 60° - 2000 kg	83,00	...
	KS208HKIH15	1,5 m		93,00	...
	KS208HKIH20	2 m		103,00	...
	KS208HKIH25	2,5 m		113,00	...
	KS208HKIH30	3 m		123,00	...
	KS208HKIH35	3,5 m		133,00	...
	KS208HKIH40	4 m		143,00	...
	KS208HKIH45	4,5 m		153,00	...
	KS208HKIH50	5 m		163,00	...
	KS208HKIH55	5,5 m		173,00	...
KS208HKIH60	6 m	183,00	...		



10 mm	KS210HKIH10	1 m	Ketting 2-sprong Elingue à 2 brins Chain with 2 strands 10 mm WLL/CMU kg <45° - 4400 kg 45° < 60° - 3200 kg	122,00	...
	KS210HKIH15	1,5 m		135,00	...
	KS210HKIH20	2 m		148,00	...
	KS210HKIH25	2,5 m		161,00	...
	KS210HKIH30	3 m		174,00	...
	KS210HKIH35	3,5 m		187,00	...
	KS210HKIH40	4 m		200,00	...
	KS210HKIH45	4,5 m		213,00	...
	KS210HKIH50	5 m		226,00	...
	KS210HKIH55	5,5 m		239,00	...
KS210HKIH60	6 m	252,00	...		



13 mm	KS213HKIH10	1 m	Ketting 2-sprong Elingue à 2 brins Chain with 2 strands 13 mm WLL/CMU kg <45° - 7400 kg 45° < 60° - 5300 kg	182,00	...
	KS213HKIH15	1,5 m		205,00	...
	KS213HKIH20	2 m		228,00	...
	KS213HKIH25	2,5 m		251,00	...
	KS213HKIH30	3 m		274,00	...
	KS213HKIH35	3,5 m		297,00	...
	KS213HKIH40	4 m		320,00	...
	KS213HKIH45	4,5 m		343,00	...
	KS213HKIH50	5 m		366,00	...
	KS213HKIH55	5,5 m		389,00	...
KS213HKIH60	6 m	412,00	...		

GRADE 100



	Code	L	Omschrijving / Description / Description	Bruto €	EAN CODE
6 mm	1KS206HKIH10	1 m	Ketting 2-sprong Elingue à 2 brins Chain with 2 strands 6 mm WLL/CMU kg <45° - 2100 kg 45° < 60° - 1500 kg	101,00	---
	1KS206HKIH15	1,5 m		111,00	---
	1KS206HKIH20	2 m		121,00	---
	1KS206HKIH25	2,5 m		131,00	---
	1KS206HKIH30	3 m		141,00	---
	1KS206HKIH35	3,5 m		151,00	---
	1KS206HKIH40	4 m		161,00	---
	1KS206HKIH45	4,5 m		171,00	---
	1KS206HKIH50	5 m		181,00	---
	1KS206HKIH55	5,5 m		191,00	---
	1KS206HKIH60	6 m	201,00	---	



8 mm	1KS208HKIH10	1 m	Ketting 2-sprong Elingue à 2 brins Chain with 2 strands 8 mm WLL/CMU kg <45° - 3500 kg 45° < 60° - 2500 kg	128,00	---
	1KS208HKIH15	1,5 m		142,00	---
	1KS208HKIH20	2 m		154,00	---
	1KS208HKIH25	2,5 m		166,00	---
	1KS208HKIH30	3 m		178,00	---
	1KS208HKIH35	3,5 m		190,00	---
	1KS208HKIH40	4 m		202,00	---
	1KS208HKIH45	4,5 m		214,00	---
	1KS208HKIH50	5 m		226,00	---
	1KS208HKIH55	5,5 m		238,00	---
	1KS208HKIH60	6 m	250,00	---	







10 mm	1KS210HKIH10	1 m	Ketting 2-sprong Elingue à 2 brins Chain with 2 strands 10 mm WLL/CMU kg <45° - 5600 kg 45° < 60° - 4000 kg	170,00	---
	1KS210HKIH15	1,5 m		192,00	---
	1KS210HKIH20	2 m		214,00	---
	1KS210HKIH25	2,5 m		236,00	---
	1KS210HKIH30	3 m		258,00	---
	1KS210HKIH35	3,5 m		280,00	---
	1KS210HKIH40	4 m		302,00	---
	1KS210HKIH45	4,5 m		324,00	---
	1KS210HKIH50	5 m		346,00	---
	1KS210HKIH55	5,5 m		368,00	---
	1KS210HKIH60	6 m	390,00	---	



13 mm	1KS213HKIH10	1 m	Ketting 2-sprong Elingue à 2 brins Chain with 2 strands 13 mm WLL/CMU kg <45° - 9400 kg 45° < 60° - 6700 kg	265,00	---
	1KS213HKIH15	1,5 m		298,00	---
	1KS213HKIH20	2 m		331,00	---
	1KS213HKIH25	2,5 m		364,00	---
	1KS213HKIH30	3 m		397,00	---
	1KS213HKIH35	3,5 m		430,00	---
	1KS213HKIH40	4 m		463,00	---
	1KS213HKIH45	4,5 m		496,00	---
	1KS213HKIH50	5 m		529,00	---
	1KS213HKIH55	5,5 m		562,00	---
	1KS213HKIH60	6 m	595,00	---	

... met gaffelhaak met klep + inkorthaak / avec crochet à chape à linguet + crochet de raccourcissement /
with clevis sling hook with latch + clevis grab hook with wing

GRADE 80

	Code	L	Omschrijving / Description / Description	Bruto €	EAN CODE
	KS406HKIH10	1 m	Ketting 4-sprong Elingue à 4 brins Chain with 4 strands 6 mm WLL/CMU kg < 45° - 2400 kg 45° < 60° - 1700 kg	110,00	...
	KS406HKIH15	1,5 m		123,00	...
	KS406HKIH20	2 m		136,00	...
	KS406HKIH25	2,5 m		149,00	...
	KS406HKIH30	3 m		162,00	...
	KS406HKIH35	3,5 m		175,00	...
	KS406HKIH40	4 m		188,00	...
	KS406HKIH45	4,5 m		201,00	...
	KS406HKIH50	5 m		214,00	...
	KS406HKIH55	5,5 m		227,00	...
KS406HKIH60	6 m	240,00	...		
	KS408HKIH10	1 m	Ketting 4-sprong Elingue à 4 brins Chain with 4 strands 8 mm WLL/CMU kg < 45° - 4200 kg 45° < 60° - 3000 kg	163,00	...
	KS408HKIH15	1,5 m		183,00	...
	KS408HKIH20	2 m		203,00	...
	KS408HKIH25	2,5 m		223,00	...
	KS408HKIH30	3 m		243,00	...
	KS408HKIH35	3,5 m		263,00	...
	KS408HKIH40	4 m		283,00	...
	KS408HKIH45	4,5 m		303,00	...
	KS408HKIH50	5 m		323,00	...
	KS408HKIH55	5,5 m		343,00	...
KS408HKIH60	6 m	363,00	...		
	KS410HKIH10	1 m	Ketting 4-sprong Elingue à 4 brins Chain with 4 strands 10 mm WLL/CMU kg < 45° - 6600 kg 45° < 60° - 4700 kg	211,00	...
	KS410HKIH15	1,5 m		238,00	...
	KS410HKIH20	2 m		265,00	...
	KS410HKIH25	2,5 m		292,00	...
	KS410HKIH30	3 m		319,00	...
	KS410HKIH35	3,5 m		346,00	...
	KS410HKIH40	4 m		373,00	...
	KS410HKIH45	4,5 m		400,00	...
	KS410HKIH50	5 m		427,00	...
	KS410HKIH55	5,5 m		454,00	...
KS410HKIH60	6 m	481,00	...		
	KS413HKIH10	1 m	Ketting 4-sprong Elingue à 4 brins Chain with 4 strands 13 mm WLL/CMU kg < 45° - 11100 kg 45° < 60° - 8000 kg	399,00	...
	KS413HKIH15	1,5 m		441,00	...
	KS413HKIH20	2 m		483,00	...
	KS413HKIH25	2,5 m		525,00	...
	KS413HKIH30	3 m		567,00	...
	KS413HKIH35	3,5 m		609,00	...
	KS413HKIH40	4 m		651,00	...
	KS413HKIH45	4,5 m		693,00	...
	KS413HKIH50	5 m		735,00	...
	KS413HKIH55	5,5 m		777,00	...
KS413HKIH60	6 m	819,00	...		

GRADE 100



6 mm

Code	L	Omschrijving / Description / Description	Bruto €	EAN CODE
1KS406HKIH10	1 m	Ketting 4-sprong Elingue à 4 brins Chain with 4 strands 6 mm WLL/CMU kg < 45° - 3200 kg 45° < 60° - 2300 kg	157,00	---
1KS406HKIH15	1,5 m		174,00	---
1KS406HKIH20	2 m		191,00	---
1KS406HKIH25	2,5 m		208,00	---
1KS406HKIH30	3 m		225,00	---
1KS406HKIH35	3,5 m		242,00	---
1KS406HKIH40	4 m		259,00	---
1KS406HKIH45	4,5 m		276,00	---
1KS406HKIH50	5 m		293,00	---
1KS406HKIH55	5,5 m		310,00	---
1KS406HKIH60	6 m	327,00	---	



8 mm

Code	L	Omschrijving / Description / Description	Bruto €	EAN CODE
1KS408HKIH10	1 m	Ketting 4-sprong Elingue à 4 brins Chain with 4 strands 8 mm WLL/CMU kg < 45° - 5300 kg 45° < 60° - 3800 kg	216,00	---
1KS408HKIH15	1,5 m		239,00	---
1KS408HKIH20	2 m		262,00	---
1KS408HKIH25	2,5 m		285,00	---
1KS408HKIH30	3 m		308,00	---
1KS408HKIH35	3,5 m		331,00	---
1KS408HKIH40	4 m		354,00	---
1KS408HKIH45	4,5 m		377,00	---
1KS408HKIH50	5 m		400,00	---
1KS408HKIH55	5,5 m		423,00	---
1KS408HKIH60	6 m	446,00	---	



10 mm

Code	L	Omschrijving / Description / Description	Bruto €	EAN CODE
1KS410HKIH10	1 m	Ketting 4-sprong Elingue à 4 brins Chain with 4 strands 10 mm WLL/CMU kg < 45° - 8400 kg 45° < 60° - 6000 kg	318,00	---
1KS410HKIH15	1,5 m		356,00	---
1KS410HKIH20	2 m		394,00	---
1KS410HKIH25	2,5 m		432,00	---
1KS410HKIH30	3 m		470,00	---
1KS410HKIH35	3,5 m		508,00	---
1KS410HKIH40	4 m		546,00	---
1KS410HKIH45	4,5 m		584,00	---
1KS410HKIH50	5 m		622,00	---
1KS410HKIH55	5,5 m		660,00	---
1KS410HKIH60	6 m	698,00	---	

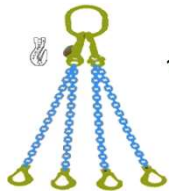

13 mm

Code	L	Omschrijving / Description / Description	Bruto €	EAN CODE
1KS413HKIH10	1 m	Ketting 4-sprong Elingue à 4 brins Chain with 4 strands 13 mm WLL/CMU kg < 45° - 14100 kg 45° < 60° - 11100 kg	546,00	---
1KS413HKIH15	1,5 m		604,00	---
1KS413HKIH20	2 m		662,00	---
1KS413HKIH25	2,5 m		720,00	---
1KS413HKIH30	3 m		778,00	---
1KS413HKIH35	3,5 m		836,00	---
1KS413HKIH40	4 m		894,00	---
1KS413HKIH45	4,5 m		952,00	---
1KS413HKIH50	5 m		1010,00	---
1KS413HKIH55	5,5 m		1068,00	---
1KS413HKIH60	6 m	1126,00	---	

GRADE 80



	Code	L	Omschrijving / Description / Description	Bruto €	EAN CODE
6 mm	KS106VH10	1 m	Kettingleng Elingue à 1 brin Chain with 1 strand 6 mm WLL/CMU kg 1120 kg	49,00	...
	KS106VH15	1,5 m		52,00	...
	KS106VH20	2 m		55,00	...
	KS106VH25	2,5 m		58,00	...
	KS106VH30	3 m		61,00	...
	KS106VH35	3,5 m		64,00	...
	KS106VH40	4 m		67,00	...
	KS106VH45	4,5 m		70,00	...
	KS106VH50	5 m		73,00	...
	KS106VH55	5,5 m		76,00	...
KS106VH60	6 m	79,00	...		



8 mm	KS108VH10	1 m	Kettingleng Elingue à 1 brin Chain with 1 strand 8 mm WLL/CMU kg 2000 kg	57,00	...
	KS108VH15	1,5 m		61,00	...
	KS108VH20	2 m		65,00	...
	KS108VH25	2,5 m		69,00	...
	KS108VH30	3 m		73,00	...
	KS108VH35	3,5 m		77,00	...
	KS108VH40	4 m		81,00	...
	KS108VH45	4,5 m		85,00	...
	KS108VH50	5 m		89,00	...
	KS108VH55	5,5 m		93,00	...
KS108VH60	6 m	97,00	...		



10 mm	KS110VH10	1 m	Kettingleng Elingue à 1 brin Chain with 1 strand 10 mm WLL/CMU kg 3200 kg	87,00	...
	KS110VH15	1,5 m		94,00	...
	KS110VH20	2 m		101,00	...
	KS110VH25	2,5 m		108,00	...
	KS110VH30	3 m		115,00	...
	KS110VH35	3,5 m		122,00	...
	KS110VH40	4 m		129,00	...
	KS110VH45	4,5 m		136,00	...
	KS110VH50	5 m		143,00	...
	KS110VH55	5,5 m		150,00	...
KS110VH60	6 m	157,00	...		



13 mm	KS113VH10	1 m	Kettingleng Elingue à 1 brin Chain with 1 strand 13 mm WLL/CMU kg 5300 kg	127,00	...
	KS113VH15	1,5 m		139,00	...
	KS113VH20	2 m		151,00	...
	KS113VH25	2,5 m		163,00	...
	KS113VH30	3 m		175,00	...
	KS113VH35	3,5 m		187,00	...
	KS113VH40	4 m		199,00	...
	KS113VH45	4,5 m		211,00	...
	KS113VH50	5 m		223,00	...
	KS113VH55	5,5 m		235,00	...
KS113VH60	6 m	247,00	...		

GRADE 100



	Code	L	Omschrijving / Description / Description	Bruto €	EAN CODE
6 mm	1KS106VH10	1 m	Kettingleng Elingue à 1 brin Chain with 1 strand 6 mm WLL/CMU kg 1500 kg	64,00	---
	1KS106VH15	1,5 m		69,00	---
	1KS106VH20	2 m		74,00	---
	1KS106VH25	2,5 m		79,00	---
	1KS106VH30	3 m		84,00	---
	1KS106VH35	3,5 m		89,00	---
	1KS106VH40	4 m		94,00	---
	1KS106VH45	4,5 m		99,00	---
	1KS106VH50	5 m		104,00	---
1KS106VH55	5,5 m	109,00	---		
1KS106VH60	6 m	114,00	---		



8 mm	1KS108VH10	1 m	Kettingleng Elingue à 1 brin Chain with 1 strand 8 mm WLL/CMU kg 2500 kg	78,00	---
	1KS108VH15	1,5 m		85,00	---
	1KS108VH20	2 m		92,00	---
	1KS108VH25	2,5 m		99,00	---
	1KS108VH30	3 m		106,00	---
	1KS108VH35	3,5 m		113,00	---
	1KS108VH40	4 m		120,00	---
	1KS108VH45	4,5 m		127,00	---
	1KS108VH50	5 m		134,00	---
1KS108VH55	5,5 m	141,00	---		
1KS108VH60	6 m	148,00	---		



10 mm	1KS110VH10	1 m	Kettingleng Elingue à 1 brin Chain with 1 strand 10 mm WLL/CMU kg 4000 kg	96,00	---
	1KS110VH15	1,5 m		107,00	---
	1KS110VH20	2 m		118,00	---
	1KS110VH25	2,5 m		129,00	---
	1KS110VH30	3 m		140,00	---
	1KS110VH35	3,5 m		151,00	---
	1KS110VH40	4 m		162,00	---
	1KS110VH45	4,5 m		173,00	---
	1KS110VH50	5 m		184,00	---
1KS110VH55	5,5 m	195,00	---		
1KS110VH60	6 m	206,00	---		



13 mm	1KS113VH10	1 m	Kettingleng Elingue à 1 brin Chain with 1 strand 13 mm WLL/CMU kg 6700 kg	150,00	---
	1KS113VH15	1,5 m		169,00	---
	1KS113VH20	2 m		188,00	---
	1KS113VH25	2,5 m		207,00	---
	1KS113VH30	3 m		226,00	---
	1KS113VH35	3,5 m		245,00	---
	1KS113VH40	4 m		264,00	---
	1KS113VH45	4,5 m		283,00	---
	1KS113VH50	5 m		302,00	---
1KS113VH55	5,5 m	321,00	---		
1KS113VH60	6 m	340,00	---		

GRADE 80



Code	L	Omschrijving / Description / Description	Bruto €	EAN CODE
KS206VH10	1 m	Ketting 2-sprong Elingue à 2 brins Chain with 2 strands 6 mm WLL/CMU kg <45° - 1600 kg 45° < 60° - 1120 kg	78,00	40510600000000000000000000000000
KS206VH15	1,5 m		84,00	40510600000000000000000000000000
KS206VH20	2 m		90,00	40510600000000000000000000000000
KS206VH25	2,5 m		96,00	40510600000000000000000000000000
KS206VH30	3 m		102,00	40510600000000000000000000000000
KS206VH35	3,5 m		108,00	40510600000000000000000000000000
KS206VH40	4 m		114,00	40510600000000000000000000000000
KS206VH45	4,5 m		120,00	40510600000000000000000000000000
KS206VH50	5 m		126,00	40510600000000000000000000000000
KS206VH55	5,5 m		132,00	40510600000000000000000000000000
KS206VH60	6 m	138,00	40510600000000000000000000000000	



KS208VH10	1 m	Ketting 2-sprong Elingue à 2 brins Chain with 2 strands 8 mm WLL/CMU kg <45° - 2800 kg 45° < 60° - 2000 kg	90,00	40510800000000000000000000000000
KS208VH15	1,5 m		100,00	40510800000000000000000000000000
KS208VH20	2 m		110,00	40510800000000000000000000000000
KS208VH25	2,5 m		120,00	40510800000000000000000000000000
KS208VH30	3 m		130,00	40510800000000000000000000000000
KS208VH35	3,5 m		140,00	40510800000000000000000000000000
KS208VH40	4 m		150,00	40510800000000000000000000000000
KS208VH45	4,5 m		160,00	40510800000000000000000000000000
KS208VH50	5 m		170,00	40510800000000000000000000000000
KS208VH55	5,5 m		180,00	40510800000000000000000000000000
KS208VH60	6 m	190,00	40510800000000000000000000000000	



KS210VH10	1 m	Ketting 2-sprong Elingue à 2 brins Chain with 2 strands 10 mm WLL/CMU kg <45° - 4400 kg 45° < 60° - 3200 kg	137,00	40511000000000000000000000000000
KS210VH15	1,5 m		150,00	40511000000000000000000000000000
KS210VH20	2 m		163,00	40511000000000000000000000000000
KS210VH25	2,5 m		176,00	40511000000000000000000000000000
KS210VH30	3 m		189,00	40511000000000000000000000000000
KS210VH35	3,5 m		202,00	40511000000000000000000000000000
KS210VH40	4 m		215,00	40511000000000000000000000000000
KS210VH45	4,5 m		228,00	40511000000000000000000000000000
KS210VH50	5 m		241,00	40511000000000000000000000000000
KS210VH55	5,5 m		254,00	40511000000000000000000000000000
KS210VH60	6 m	267,00	40511000000000000000000000000000	



KS213VH10	1 m	Ketting 2-sprong Elingue à 2 brins Chain with 2 strands 13 mm WLL/CMU kg <45° - 7400 kg 45° < 60° - 5300 kg	221,00	40511300000000000000000000000000
KS213VH15	1,5 m		244,00	40511300000000000000000000000000
KS213VH20	2 m		267,00	40511300000000000000000000000000
KS213VH25	2,5 m		290,00	40511300000000000000000000000000
KS213VH30	3 m		313,00	40511300000000000000000000000000
KS213VH35	3,5 m		336,00	40511300000000000000000000000000
KS213VH40	4 m		359,00	40511300000000000000000000000000
KS213VH45	4,5 m		382,00	40511300000000000000000000000000
KS213VH50	5 m		405,00	40511300000000000000000000000000
KS213VH55	5,5 m		428,00	40511300000000000000000000000000
KS213VH60	6 m	451,00	40511300000000000000000000000000	

GRADE 100



	Code	L	Omschrijving / Description / Description	Bruto €	EAN CODE
6 mm	1KS206VH10	1 m	Ketting 2-sprong Elingue à 2 brins Chain with 2 strands 6 mm WLL/CMU kg <45° - 2100 kg 45° < 60° - 1500 kg	110,00	...
	1KS206VH15	1,5 m		120,00	...
	1KS206VH20	2 m		130,00	...
	1KS206VH25	2,5 m		140,00	...
	1KS206VH30	3 m		150,00	...
	1KS206VH35	3,5 m		160,00	...
	1KS206VH40	4 m		170,00	...
	1KS206VH45	4,5 m		180,00	...
	1KS206VH50	5 m		190,00	...
	1KS206VH55	5,5 m		200,00	...
1KS206VH60	6 m	210,00	...		



8 mm	1KS208VH10	1 m	Ketting 2-sprong Elingue à 2 brins Chain with 2 strands 8 mm WLL/CMU kg <45° - 3500 kg 45° < 60° - 2500 kg	136,00	...
	1KS208VH15	1,5 m		150,00	...
	1KS208VH20	2 m		164,00	...
	1KS208VH25	2,5 m		178,00	...
	1KS208VH30	3 m		192,00	...
	1KS208VH35	3,5 m		206,00	...
	1KS208VH40	4 m		220,00	...
	1KS208VH45	4,5 m		234,00	...
	1KS208VH50	5 m		248,00	...
	1KS208VH55	5,5 m		262,00	...
1KS208VH60	6 m	276,00	...		



10 mm	1KS210VH10	1 m	Ketting 2-sprong Elingue à 2 brins Chain with 2 strands 10 mm WLL/CMU kg <45° - 5600 kg 45° < 60° - 4000 kg	182,00	...
	1KS210VH15	1,5 m		204,00	...
	1KS210VH20	2 m		226,00	...
	1KS210VH25	2,5 m		248,00	...
	1KS210VH30	3 m		270,00	...
	1KS210VH35	3,5 m		292,00	...
	1KS210VH40	4 m		314,00	...
	1KS210VH45	4,5 m		336,00	...
	1KS210VH50	5 m		358,00	...
	1KS210VH55	5,5 m		380,00	...
1KS210VH60	6 m	402,00	...		



13 mm	1KS213VH10	1 m	Ketting 2-sprong Elingue à 2 brins Chain with 2 strands 13 mm WLL/CMU kg <45° - 9400 kg 45° < 60° - 6700 kg	281,00	...
	1KS213VH15	1,5 m		314,00	...
	1KS213VH20	2 m		347,00	...
	1KS213VH25	2,5 m		380,00	...
	1KS213VH30	3 m		413,00	...
	1KS213VH35	3,5 m		446,00	...
	1KS213VH40	4 m		479,00	...
	1KS213VH45	4,5 m		512,00	...
	1KS213VH50	5 m		545,00	...
	1KS213VH55	5,5 m		578,00	...
1KS213VH60	6 m	611,00	...		

GRADE 80



6 mm

Code	L	Omschrijving / Description / Description	Bruto €	EAN CODE
KS406VH10	1 m	Ketting 4-sprong Elingue à 4 brins Chain with 4 strands 6 mm WLL/CMU kg < 45° - 2400 kg 45° < 60° - 1700 kg	137,00	...
KS406VH15	1,5 m		150,00	...
KS406VH20	2 m		163,00	...
KS406VH25	2,5 m		176,00	...
KS406VH30	3 m		189,00	...
KS406VH35	3,5 m		202,00	...
KS406VH40	4 m		215,00	...
KS406VH45	4,5 m		228,00	...
KS406VH50	5 m		241,00	...
KS406VH55	5,5 m		254,00	...
KS406VH60	6 m	267,00	...	



8 mm

KS408VH10	1 m	Ketting 4-sprong Elingue à 4 brins Chain with 4 strands 8 mm WLL/CMU kg < 45° - 4200 kg 45° < 60° - 3000 kg	191,00	...
KS408VH15	1,5 m		211,00	...
KS408VH20	2 m		231,00	...
KS408VH25	2,5 m		251,00	...
KS408VH30	3 m		271,00	...
KS408VH35	3,5 m		291,00	...
KS408VH40	4 m		311,00	...
KS408VH45	4,5 m		331,00	...
KS408VH50	5 m		351,00	...
KS408VH55	5,5 m		371,00	...
KS408VH60	6 m	391,00	...	



10 mm

KS410VH10	1 m	Ketting 4-sprong Elingue à 4 brins Chain with 4 strands 10 mm WLL/CMU kg < 45° - 6600 kg 45° < 60° - 4700 kg	273,00	...
KS410VH15	1,5 m		300,00	...
KS410VH20	2 m		327,00	...
KS410VH25	2,5 m		354,00	...
KS410VH30	3 m		381,00	...
KS410VH35	3,5 m		408,00	...
KS410VH40	4 m		435,00	...
KS410VH45	4,5 m		462,00	...
KS410VH50	5 m		489,00	...
KS410VH55	5,5 m		516,00	...
KS410VH60	6 m	543,00	...	



13 mm

KS413VH10	1 m	Ketting 4-sprong Elingue à 4 brins Chain with 4 strands 13 mm WLL/CMU kg < 45° - 11100 kg 45° < 60° - 8000 kg	420,00	...
KS413VH15	1,5 m		462,00	...
KS413VH20	2 m		504,00	...
KS413VH25	2,5 m		546,00	...
KS413VH30	3 m		588,00	...
KS413VH35	3,5 m		630,00	...
KS413VH40	4 m		672,00	...
KS413VH45	4,5 m		714,00	...
KS413VH50	5 m		756,00	...
KS413VH55	5,5 m		798,00	...
KS413VH60	6 m	840,00	...	



GRADE 100



Code	L	Omschrijving / Description / Description	Bruto €	EAN CODE
1KS406VH10	1 m	Ketting 4-sprong Elingue à 4 brins Chain with 4 strands 6 mm WLL/CMU kg < 45° - 3200 kg 45° < 60° - 2300 kg	169,00	...
1KS406VH15	1,5 m		186,00	...
1KS406VH20	2 m		203,00	...
1KS406VH25	2,5 m		220,00	...
1KS406VH30	3 m		237,00	...
1KS406VH35	3,5 m		254,00	...
1KS406VH40	4 m		271,00	...
1KS406VH45	4,5 m		288,00	...
1KS406VH50	5 m		305,00	...
1KS406VH55	5,5 m		322,00	...
1KS406VH60	6 m	339,00	...	



1KS408VH10	1 m	Ketting 4-sprong Elingue à 4 brins Chain with 4 strands 8 mm WLL/CMU kg < 45° - 5300 kg 45° < 60° - 3800 kg	234,00	...
1KS408VH15	1,5 m		257,00	...
1KS408VH20	2 m		280,00	...
1KS408VH25	2,5 m		303,00	...
1KS408VH30	3 m		326,00	...
1KS408VH35	3,5 m		349,00	...
1KS408VH40	4 m		372,00	...
1KS408VH45	4,5 m		395,00	...
1KS408VH50	5 m		418,00	...
1KS408VH55	5,5 m		441,00	...
1KS408VH60	6 m	464,00	...	



1KS410VH10	1 m	Ketting 4-sprong Elingue à 4 brins Chain with 4 strands 10 mm WLL/CMU kg < 45° - 8400 kg 45° < 60° - 6000 kg	320,00	...
1KS410VH15	1,5 m		358,00	...
1KS410VH20	2 m		396,00	...
1KS410VH25	2,5 m		434,00	...
1KS410VH30	3 m		472,00	...
1KS410VH35	3,5 m		510,00	...
1KS410VH40	4 m		548,00	...
1KS410VH45	4,5 m		586,00	...
1KS410VH50	5 m		624,00	...
1KS410VH55	5,5 m		662,00	...
1KS410VH60	6 m	700,00	...	



1KS413VH10	1 m	Ketting 4-sprong Elingue à 4 brins Chain with 4 strands 13 mm WLL/CMU kg < 45° - 14100 kg 45° < 60° - 11100 kg	525,00	...
1KS413VH15	1,5 m		583,00	...
1KS413VH20	2 m		641,00	...
1KS413VH25	2,5 m		699,00	...
1KS413VH30	3 m		757,00	...
1KS413VH35	3,5 m		815,00	...
1KS413VH40	4 m		873,00	...
1KS413VH45	4,5 m		931,00	...
1KS413VH50	5 m		989,00	...
1KS413VH55	5,5 m		1047,00	...
1KS413VH60	6 m	1105,00	...	

... met gaffelveiligheidshaak + inkorthaak / avec crochet de sécurité à chape + crochet de raccourcissement /
with clevis type autolock safety hook + clevis grab hook with wing

GRADE 80



	Code	L	Omschrijving / Description / Description	Bruto €	EAN CODE
6 mm	KS106VHIH10	1 m	Kettingleng Elingue à 1 brin Chain with 1 strand 6 mm WLL/CMU kg 1120 kg	52,00	...
	KS106VHIH15	1,5 m		55,00	...
	KS106VHIH20	2 m		58,00	...
	KS106VHIH25	2,5 m		61,00	...
	KS106VHIH30	3 m		64,00	...
	KS106VHIH35	3,5 m		67,00	...
	KS106VHIH40	4 m		70,00	...
	KS106VHIH45	4,5 m		73,00	...
	KS106VHIH50	5 m		76,00	...
	KS106VHIH55	5,5 m		79,00	...
	KS106VHIH60	6 m	82,00	...	



8 mm	KS108VHIH10	1 m	Kettingleng Elingue à 1 brin Chain with 1 strand 8 mm WLL/CMU kg 2000 kg	61,00	...
	KS108VHIH15	1,5 m		65,00	...
	KS108VHIH20	2 m		69,00	...
	KS108VHIH25	2,5 m		73,00	...
	KS108VHIH30	3 m		77,00	...
	KS108VHIH35	3,5 m		81,00	...
	KS108VHIH40	4 m		85,00	...
	KS108VHIH45	4,5 m		89,00	...
	KS108VHIH50	5 m		93,00	...
	KS108VHIH55	5,5 m		97,00	...
	KS108VHIH60	6 m	101,00	...	



10 mm	KS110VHIH10	1 m	Kettingleng Elingue à 1 brin Chain with 1 strand 10 mm WLL/CMU kg 3200 kg	92,00	...
	KS110VHIH15	1,5 m		100,00	...
	KS110VHIH20	2 m		108,00	...
	KS110VHIH25	2,5 m		116,00	...
	KS110VHIH30	3 m		124,00	...
	KS110VHIH35	3,5 m		132,00	...
	KS110VHIH40	4 m		140,00	...
	KS110VHIH45	4,5 m		148,00	...
	KS110VHIH50	5 m		156,00	...
	KS110VHIH55	5,5 m		164,00	...
	KS110VHIH60	6 m	172,00	...	



13 mm	KS113VHIH10	1 m	Kettingleng Elingue à 1 brin Chain with 1 strand 13 mm WLL/CMU kg 5300 kg	143,00	...
	KS113VHIH15	1,5 m		155,00	...
	KS113VHIH20	2 m		167,00	...
	KS113VHIH25	2,5 m		179,00	...
	KS113VHIH30	3 m		191,00	...
	KS113VHIH35	3,5 m		203,00	...
	KS113VHIH40	4 m		215,00	...
	KS113VHIH45	4,5 m		227,00	...
	KS113VHIH50	5 m		239,00	...
	KS113VHIH55	5,5 m		251,00	...
	KS113VHIH60	6 m	263,00	...	

... met gaffelveiligheidshaak + inkorthaak / avec crochet de sécurité à chape + crochet de raccourcissement /
with clevis type autolock safety hook + clevis grab hook with wing

GRADE 80



	Code	L	Omschrijving / Description / Description	Bruto €	EAN CODE
6 mm	KS206VHIH10	1 m	Ketting 2-sprong Elingue à 2 brins Chain with 2 strands 6 mm WLL/CMU kg <45° - 1600 kg 45° < 60° - 1120 kg	85,00	...
	KS206VHIH15	1,5 m		91,00	...
	KS206VHIH20	2 m		97,00	...
	KS206VHIH25	2,5 m		103,00	...
	KS206VHIH30	3 m		109,00	...
	KS206VHIH35	3,5 m		115,00	...
	KS206VHIH40	4 m		121,00	...
	KS206VHIH45	4,5 m		127,00	...
	KS206VHIH50	5 m		133,00	...
	KS206VHIH55	5,5 m		139,00	...
KS206VHIH60	6 m	145,00	...		



8 mm	KS208VHIH10	1 m	Ketting 2-sprong Elingue à 2 brins Chain with 2 strands 8 mm WLL/CMU kg <45° - 2800 kg 45° < 60° - 2000 kg	97,00	...
	KS208VHIH15	1,5 m		107,00	...
	KS208VHIH20	2 m		117,00	...
	KS208VHIH25	2,5 m		127,00	...
	KS208VHIH30	3 m		137,00	...
	KS208VHIH35	3,5 m		147,00	...
	KS208VHIH40	4 m		157,00	...
	KS208VHIH45	4,5 m		167,00	...
	KS208VHIH50	5 m		177,00	...
	KS208VHIH55	5,5 m		187,00	...
KS208VHIH60	6 m	197,00	...		



10 mm	KS210VHIH10	1 m	Ketting 2-sprong Elingue à 2 brins Chain with 2 strands 10 mm WLL/CMU kg <45° - 4400 kg 45° < 60° - 3200 kg	153,00	...
	KS210VHIH15	1,5 m		166,00	...
	KS210VHIH20	2 m		179,00	...
	KS210VHIH25	2,5 m		192,00	...
	KS210VHIH30	3 m		205,00	...
	KS210VHIH35	3,5 m		218,00	...
	KS210VHIH40	4 m		231,00	...
	KS210VHIH45	4,5 m		244,00	...
	KS210VHIH50	5 m		257,00	...
	KS210VHIH55	5,5 m		270,00	...
KS210VHIH60	6 m	283,00	...		



13 mm	KS213VHIH10	1 m	Ketting 2-sprong Elingue à 2 brins Chain with 2 strands 13 mm WLL/CMU kg <45° - 7400 kg 45° < 60° - 5300 kg	253,00	...
	KS213VHIH15	1,5 m		276,00	...
	KS213VHIH20	2 m		299,00	...
	KS213VHIH25	2,5 m		322,00	...
	KS213VHIH30	3 m		345,00	...
	KS213VHIH35	3,5 m		368,00	...
	KS213VHIH40	4 m		391,00	...
	KS213VHIH45	4,5 m		414,00	...
	KS213VHIH50	5 m		437,00	...
	KS213VHIH55	5,5 m		460,00	...
KS213VHIH60	6 m	483,00	...		

GRADE 100



	Code	L	Omschrijving / Description / Description	Bruto €	EAN CODE
6 mm	1KS206VHIH10	1 m	Ketting 2-sprong Elingue à 2 brins Chain with 2 strands 6 mm WLL/CMU kg <45° - 2100 kg 45° < 60° - 1500 kg	120,00	000000 000000 000000 000000
	1KS206VHIH15	1,5 m		130,00	000000 000000 000000 000000
	1KS206VHIH20	2 m		140,00	000000 000000 000000 000000
	1KS206VHIH25	2,5 m		150,00	000000 000000 000000 000000
	1KS206VHIH30	3 m		160,00	000000 000000 000000 000000
	1KS206VHIH35	3,5 m		170,00	000000 000000 000000 000000
	1KS206VHIH40	4 m		180,00	000000 000000 000000 000000
	1KS206VHIH45	4,5 m		190,00	000000 000000 000000 000000
	1KS206VHIH50	5 m		200,00	000000 000000 000000 000000
	1KS206VHIH55	5,5 m		210,00	000000 000000 000000 000000
1KS206VHIH60	6 m	220,00	000000 000000 000000 000000		



8 mm	1KS208VHIH10	1 m	Ketting 2-sprong Elingue à 2 brins Chain with 2 strands 8 mm WLL/CMU kg <45° - 3500 kg 45° < 60° - 2500 kg	148,00	000000 000000 000000 000000
	1KS208VHIH15	1,5 m		162,00	000000 000000 000000 000000
	1KS208VHIH20	2 m		176,00	000000 000000 000000 000000
	1KS208VHIH25	2,5 m		190,00	000000 000000 000000 000000
	1KS208VHIH30	3 m		204,00	000000 000000 000000 000000
	1KS208VHIH35	3,5 m		218,00	000000 000000 000000 000000
	1KS208VHIH40	4 m		232,00	000000 000000 000000 000000
	1KS208VHIH45	4,5 m		246,00	000000 000000 000000 000000
	1KS208VHIH50	5 m		260,00	000000 000000 000000 000000
	1KS208VHIH55	5,5 m		274,00	000000 000000 000000 000000
1KS208VHIH60	6 m	288,00	000000 000000 000000 000000		







10 mm	1KS210VHIH10	1 m	Ketting 2-sprong Elingue à 2 brins Chain with 2 strands 10 mm WLL/CMU kg <45° - 5600 kg 45° < 60° - 4000 kg	205,00	000000 000000 000000 000000
	1KS210VHIH15	1,5 m		227,00	000000 000000 000000 000000
	1KS210VHIH20	2 m		249,00	000000 000000 000000 000000
	1KS210VHIH25	2,5 m		271,00	000000 000000 000000 000000
	1KS210VHIH30	3 m		293,00	000000 000000 000000 000000
	1KS210VHIH35	3,5 m		315,00	000000 000000 000000 000000
	1KS210VHIH40	4 m		337,00	000000 000000 000000 000000
	1KS210VHIH45	4,5 m		359,00	000000 000000 000000 000000
	1KS210VHIH50	5 m		381,00	000000 000000 000000 000000
	1KS210VHIH55	5,5 m		403,00	000000 000000 000000 000000
1KS210VHIH60	6 m	425,00	000000 000000 000000 000000		



13 mm	1KS213VHIH10	1 m	Ketting 2-sprong Elingue à 2 brins Chain with 2 strands 13 mm WLL/CMU kg <45° - 9400 kg 45° < 60° - 6700 kg	314,00	000000 000000 000000 000000
	1KS213VHIH15	1,5 m		347,00	000000 000000 000000 000000
	1KS213VHIH20	2 m		380,00	000000 000000 000000 000000
	1KS213VHIH25	2,5 m		413,00	000000 000000 000000 000000
	1KS213VHIH30	3 m		446,00	000000 000000 000000 000000
	1KS213VHIH35	3,5 m		479,00	000000 000000 000000 000000
	1KS213VHIH40	4 m		512,00	000000 000000 000000 000000
	1KS213VHIH45	4,5 m		545,00	000000 000000 000000 000000
	1KS213VHIH50	5 m		578,00	000000 000000 000000 000000
	1KS213VHIH55	5,5 m		611,00	000000 000000 000000 000000
1KS213VHIH60	6 m	644,00	000000 000000 000000 000000		

... met gaffelveiligheidshaak + inkorthaak / avec crochet de sécurité à chape + crochet de raccourcissement /
with clevis type autolock safety hook + clevis grab hook with wing

GRADE 80

	Code	L	Omschrijving / Description / Description	Bruto €	EAN CODE
	KS406VHIH10	1 m	Ketting 4-sprong Elingue à 4 brins Chain with 4 strands 6 mm WLL/CMU kg < 45° - 2400 kg 45° < 60° - 1700 kg	152,00	...
	KS406VHIH15	1,5 m		165,00	...
	KS406VHIH20	2 m		178,00	...
	KS406VHIH25	2,5 m		191,00	...
	KS406VHIH30	3 m		204,00	...
	KS406VHIH35	3,5 m		217,00	...
	KS406VHIH40	4 m		230,00	...
	KS406VHIH45	4,5 m		243,00	...
	KS406VHIH50	5 m		256,00	...
	KS406VHIH55	5,5 m		269,00	...
KS406VHIH60	6 m	282,00	...		
	KS408VHIH10	1 m	Ketting 4-sprong Elingue à 4 brins Chain with 4 strands 8 mm WLL/CMU kg < 45° - 4200 kg 45° < 60° - 3000 kg	205,00	...
	KS408VHIH15	1,5 m		225,00	...
	KS408VHIH20	2 m		245,00	...
	KS408VHIH25	2,5 m		265,00	...
	KS408VHIH30	3 m		285,00	...
	KS408VHIH35	3,5 m		305,00	...
	KS408VHIH40	4 m		325,00	...
	KS408VHIH45	4,5 m		345,00	...
	KS408VHIH50	5 m		365,00	...
	KS408VHIH55	5,5 m		385,00	...
KS408VHIH60	6 m	405,00	...		
	KS410VHIH10	1 m	Ketting 4-sprong Elingue à 4 brins Chain with 4 strands 10 mm WLL/CMU kg < 45° - 6600 kg 45° < 60° - 4700 kg	273,00	...
	KS410VHIH15	1,5 m		300,00	...
	KS410VHIH20	2 m		327,00	...
	KS410VHIH25	2,5 m		354,00	...
	KS410VHIH30	3 m		381,00	...
	KS410VHIH35	3,5 m		408,00	...
	KS410VHIH40	4 m		435,00	...
	KS410VHIH45	4,5 m		462,00	...
	KS410VHIH50	5 m		489,00	...
	KS410VHIH55	5,5 m		516,00	...
KS410VHIH60	6 m	543,00	...		
	KS413VHIH10	1 m	Ketting 4-sprong Elingue à 4 brins Chain with 4 strands 13 mm WLL/CMU kg < 45° - 11100 kg 45° < 60° - 8000 kg	494,00	...
	KS413VHIH15	1,5 m		536,00	...
	KS413VHIH20	2 m		578,00	...
	KS413VHIH25	2,5 m		620,00	...
	KS413VHIH30	3 m		662,00	...
	KS413VHIH35	3,5 m		704,00	...
	KS413VHIH40	4 m		746,00	...
	KS413VHIH45	4,5 m		788,00	...
	KS413VHIH50	5 m		830,00	...
	KS413VHIH55	5,5 m		872,00	...
KS413VHIH60	6 m	914,00	...		

GRADE 100



Code	L	Omschrijving / Description / Description	Bruto €	EAN CODE
1KS406VHIH10	1 m	Ketting 4-sprong Elingue à 4 brins Chain with 4 strands 6 mm WLL/CMU kg < 45° - 3200 kg 45° < 60° - 2300 kg	189,00	00000 0000000000 000000
1KS406VHIH15	1,5 m		206,00	00000 0000000000 000000
1KS406VHIH20	2 m		223,00	00000 0000000000 000000
1KS406VHIH25	2,5 m		240,00	00000 0000000000 000000
1KS406VHIH30	3 m		257,00	00000 0000000000 000000
1KS406VHIH35	3,5 m		274,00	00000 0000000000 000000
1KS406VHIH40	4 m		291,00	00000 0000000000 000000
1KS406VHIH45	4,5 m		308,00	00000 0000000000 000000
1KS406VHIH50	5 m		325,00	00000 0000000000 000000
1KS406VHIH55	5,5 m		342,00	00000 0000000000 000000
1KS406VHIH60	6 m	359,00	00000 0000000000 000000	

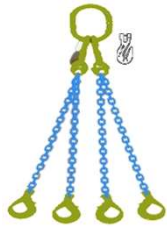

1KS408VHIH10	1 m	Ketting 4-sprong Elingue à 4 brins Chain with 4 strands 8 mm WLL/CMU kg < 45° - 5300 kg 45° < 60° - 3800 kg	257,00	00000 0000000000 000000
1KS408VHIH15	1,5 m		280,00	00000 0000000000 000000
1KS408VHIH20	2 m		303,00	00000 0000000000 000000
1KS408VHIH25	2,5 m		326,00	00000 0000000000 000000
1KS408VHIH30	3 m		349,00	00000 0000000000 000000
1KS408VHIH35	3,5 m		372,00	00000 0000000000 000000
1KS408VHIH40	4 m		395,00	00000 0000000000 000000
1KS408VHIH45	4,5 m		418,00	00000 0000000000 000000
1KS408VHIH50	5 m		441,00	00000 0000000000 000000
1KS408VHIH55	5,5 m		464,00	00000 0000000000 000000
1KS408VHIH60	6 m	487,00	00000 0000000000 000000	







KS410VHIH10	1 m	Ketting 4-sprong Elingue à 4 brins Chain with 4 strands 10 mm WLL/CMU kg < 45° - 8400 kg 45° < 60° - 6000 kg	366,00	00000 0000000000 000000
KS410VHIH15	1,5 m		404,00	00000 0000000000 000000
KS410VHIH20	2 m		442,00	00000 0000000000 000000
KS410VHIH25	2,5 m		480,00	00000 0000000000 000000
KS410VHIH30	3 m		518,00	00000 0000000000 000000
KS410VHIH35	3,5 m		556,00	00000 0000000000 000000
KS410VHIH40	4 m		594,00	00000 0000000000 000000
KS410VHIH45	4,5 m		632,00	00000 0000000000 000000
KS410VHIH50	5 m		670,00	00000 0000000000 000000
KS410VHIH55	5,5 m		708,00	00000 0000000000 000000
KS410VHIH60	6 m	746,00	00000 0000000000 000000	











1KS413VHIH10	1 m	Ketting 4-sprong Elingue à 4 brins Chain with 4 strands 13 mm WLL/CMU kg < 45° - 14100 kg 45° < 60° - 11100 kg	635,00	00000 0000000000 000000
1KS413VHIH15	1,5 m		693,00	00000 0000000000 000000
1KS413VHIH20	2 m		751,00	00000 0000000000 000000
1KS413VHIH25	2,5 m		809,00	00000 0000000000 000000
1KS413VHIH30	3 m		867,00	00000 0000000000 000000
1KS413VHIH35	3,5 m		925,00	00000 0000000000 000000
1KS413VHIH40	4 m		983,00	00000 0000000000 000000
1KS413VHIH45	4,5 m		1041,00	00000 0000000000 000000
1KS413VHIH50	5 m		1099,00	00000 0000000000 000000
1KS413VHIH55	5,5 m		1157,00	00000 0000000000 000000
1KS413VHIH60	6 m	1215,00	00000 0000000000 000000	





Handkettingtakels - Palans manuel à chaîne - Manual chain hoists

Afwijkend hijshoogtes worden niet vermeld. Prijzen steeds verkrijgbaar op aanvraag.
Des hauteurs levages irréguliers ne sont pas mentionnées. Prix toujours disponible sur demande.
Deviant dimensions are not mentioned. Price always available on request.

Code	Hijshoogte / Hauteur levage / Hoist height	WLL/CMU kg	€	EAN CODE
HT0050/BODY	/	500	108,00	
HT005030	3 m		139,00	
HT005060	6 m		188,00	
HT005090	9 m		220,00	

HT0100/BODY	/	1000	118,00	
HT0100/BODYZW	/		118,00	
HT010030	3 m		162,00	
HT010060	6 m		206,00	
HT010090	9 m		241,00	



















HT0150/BODY	/	1500	158,00	
HT015030	3 m		208,00	
HT015060	6 m		272,00	
HT015090	9 m		314,00	

HT0200/BODY	/	2000	173,00	
HT020030	3 m		220,00	
HT020060	6 m		274,00	
HT020090	9 m		328,00	

Tarieven last- en trekkettingen voor handkettingtakels en rateltakels op aanvraag.
Tarifs de chaîne de levage calibrée ou de manœuvre pour palan manuel / palan à levier sur demande.
Prices for manual hoist lifting chains or pulling chains on request.



Handkettingtakels - Palans manuel à chaîne - Manual chain hoists

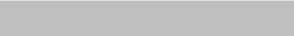

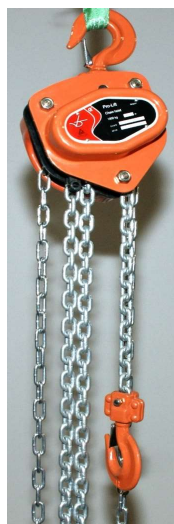











Code	Hijshoogte / Hauteur levage / Hoist height	WLL/CMU kg	€	EAN CODE
HT0300/BODY	/	3000	204,00	
HT030030	3 m		284,00	
HT030060	6 m		386,00	
HT030090	9 m		461,00	
HT0500/BODY	/	5000	317,00	
HT050030	3 m		440,00	
HT050060	6 m		582,00	
HT050090	9 m		733,00	
HT1000/BODY	/	10000	623,00	
HT100030	3 m		821,00	
HT100060	6 m		1.105,00	
HT100090	9 m		1.383,00	
HT1500/BODY	/	15000	1.737,00	
HT150030	3 m		2.270,00	
HT150060	6 m		2.855,00	
HT150090	9 m		3.443,00	
HT2000/BODY	/	20000	1.737,00	
HT200030	3 m		2.470,00	
HT200060	6 m		3.025,00	
HT200090	9 m		3.743,00	



Bedieningshoogte = hijshoogte -0,5m / Longueur de la chaîne à main = hauteur levage -0,5m
Length of chain = hoist height -0,5m

Rateltakels - Palans à levier - Lever hoists

Afwijkend hijshoogtes worden niet vermeld. Prijzen steeds verkrijgbaar op aanvraag.
Des hauteurs levages irréguliers ne sont pas mentionnées. Prix toujours disponible sur demande.
Deviant dimensions are not mentioned. Price always available on request.

Code	Hijshoogte / Hauteur levage / Hoist height	WLL/CMU kg	Bruto €	EAN CODE
RT002020	2 m	250	145,00	
RT007015	1,5 m	750	177,00	
RT007030	3 m		191,00	
RT007060	6 m		220,00	
RT015015	1,5 m	1500	225,00	
RT015030	3 m		247,00	
RT015060	6 m		276,00	
RT03015	1,5 m	3000	343,00	
RT03030	3 m		358,00	
RT03060	6 m		427,00	
RT06015	1,5 m	6000	553,00	
RT06030	3 m		605,00	
RT09015	1,5 m	9000	765,00	
RT09030	3 m		934,00	



Wisselstukken HT & RT - Pièces détachées HT et RT - Spare Parts HT & RT

Klepkit voor haak met klep – Kit à linguet pour crochet à linguet – Kit for clevis sling hook

Code	Voor takels / Pour palan / For hoist	Bruto €	
HTKLEP05HD	500kg	7,50	
HTKLEP10HD	1.000kg	8,50	
HTKLEP15HD	1.500kg	9,50	
HTKLEP20HD	2.000kg	10,50	
HTKLEP30HD	3.000kg	12,00	
HTKLEP50HD	5.000kg	13,60	

Onderhaak voor handkettingtakels - Crochet inférieur pour palans à chaîne - Bottom hook for manual chain hoist

Code	Voor takels / Pour palan / For hoist	Bruto €	
HTOH005	500kg	35,00	
HTOH010	1.000kg	38,00	
HTOH015	1.500kg	41,00	
HTOH020	2.000kg	45,00	
HTOH030	3.000kg	83,00	
HTOH050	5.000kg	183,00	

Bovenhaak voor handkettingtakels - Crochet supérieur pour palans à chaîne - Top hook for manual chain hoist

Code	Voor takels / Pour palan / For hoist	Bruto €	
HTTH05	500kg	35,00	
HTTH10	1.000kg	38,00	
HTTH15	1.500kg	41,00	
HTTH20	2.000kg	45,00	
HTTH30	3.000kg	83,00	
HTTH50	5.000kg	183,00	

Onderhaak voor rateltakels - Crochet inférieur pour palans à levier - Bottom hook for lever hoist

Code	Voor takels / Pour palan / For hoist	Bruto €	
RTOH075	750kg	35,00	
RTOH015	1.500kg	41,00	
RTOH030	3.000kg	83,00	
RTOH60	6.000kg	On request	
RTOH90	9.000kg	On request	

Bovenhaak voor rateltakels - Crochet supérieur pour palans à levier - Top hook for lever hoist

Code	Voor takels / Pour palan / For hoist	Bruto €	
RTTH07	750kg	35,00	
RTTH15	1.500kg	41,00	
RTTH30	3.000kg	83,00	
RTTH60	6.000kg	On request	
RTTH90	9.000kg	On request	

Klepkit voor haak met klep – Kit à linguet pour crochet à linguet – Kit for clevis sling hook

Code	Voor takels / Pour palan / For hoist	Bruto €	
RTKLEP025HD	250kg	7,50	
RTKLEP075HD	750kg	8,50	
RTKLEP150HD	1.500kg	9,50	
RTKLEP300HD	3.000kg	10,50	
RTKLEP60HD	6.000kg	12,00	
RTKLEP90HD	9.000kg	13,60	

Pro-lift onderhoudspray voor kettingen - Pro-lift spray d'entretien pour chaînes - Pro-lift maintenance spray for chains

Code	Voor takels / Pour palan / For hoist	Bruto €	EAN CODE
SPRAY	alle types - tous les types - all types	9,50	

Permanente hefmagneten met scharnierend oog - Aimants permanents avec oeil articulé
Permanent magnetic lifters with rotatable lifting eye



Code	Vlak materiaal / Profile plat / Flat profile		Bruto €	EAN CODE	
	WLL/CMU kg	Dikte / Epaisseur / Thickness			
HM0100EM	100	15 mm	261,00		
HM0300EM	300	20 mm	434,00		
HM0600EM	600	25 mm	686,00		
HM1000EM	1000	30 mm	1090,00		
HM1500EM	1500	40 mm	1230,00		
HM2000EM	2000	40 mm	2273,00		

Permanente hefmagneten met vast oog - Aimants permanents avec oeil fix
Permanent magnetic lifters with fixed lifting eye







Code	Vlak materiaal / Profile plat / Flat profile		Bruto €	EAN CODE	
	WLL/CMU kg	Dikte / Epaisseur / Thickness			
HMVO0100	100 kg	15 mm	383,00		
HMVO0300	300 kg	20 mm	600,00		
HMVO0600	600 kg	25 mm	871,00		
HMVO1000	1000 kg	30 mm	1355,00		







NIEUW
NOUVEAU
NEW







**Balkenklemmen - Pincés à profile - Beam clamps
Standaard/Standard/Standard**

Code	opening / ouverture	WLL/CMU kg	Bruto €	EAN CODE
BK010	75-220 mm	1000	72	
BK020	75-220 mm	2000	78	
BK030	75-320 mm	3000	136	
BK050	80-320 mm	5000	146	
BK100	90-32 mm	10000	277	

Balkenklemmen met ophangoog - Pincés à profile avec oeuil de suspension - Beam clamps with suspension eye PROLIFT OEM

Code	opening / ouverture	WLL/CMU kg	Bruto €	EAN CODE
BK0100HM	75-230 mm	1000	75	
BK0200HM	75-230 mm	2000	87	
BK0300HM	80-320 mm	3000	150	
BK0500HM	90-320 mm	5000	167	
BK1000HM	90-320 mm	10000	295	

Balkenklemmen - Pincés à profile - Beam clamps HEAVY DUTY

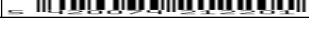
Code	opening / ouverture	WLL/CMU kg	Bruto €	EAN CODE
BK010HD	75 - 220 mm	1000	102	
BK020HD	80 - 320 mm	2000	110	
BK030HD	80 - 320 mm	3000	216	
BK050HD	80 - 320 mm	5000	255	
BK100HD	80 - 350 mm	10000	444	



Vabotec bvba
Starrenhoflaan 33, 2950 Kapellen



+32 (0) 3 660 08 94
info@vabotec.be

Verticale platenklemmen - Pinces à tôle verticale - Vertical plate clamps PROLIFT OEM



Code	Opening /	Omschrijving / Description /	WLL/CMU kg	Bruto € /	EAN Code
PKU0EM05	0-20 mm	Scharnierbaar oog / Oeil pivotable / Swivelling eye	500	115,00	
PKU0EM10	0-20 mm		1000		163,00
PKU0EM20	0-20 mm		2000	214,00	
PKU0EM30	0-30 mm		3000		318,00
PKU0EM50	0-50 mm		5000	427,00	

Horizontale platenklemmen - Pinces à tôle horizontale - Horizontal plate clamps NB



Code	Opening / Ouverture	Omschrijving / Description / Description	WLL/CMU kg	Bruto € /	EAN Code
PKHORN0251T	0 - 25 mm	Niet beschadigend / Anti-marquage / Non damaging	1000	380,00	
PKHORN0452T	0 - 45 mm		2000		494,00
PKHORN0453T	0 - 45 mm		3000	589,00	
PKHORN0504T	0 - 50 mm	Teflon	4000		741,00
PKHORN0506T	0 - 50 mm		6000	861,00	



NIEUW
NOUVEAU
NEW



NIEUW
NOUVEAU
NEW

Horizontale platenklemmen - Pinces à tôle horizontale - Horizontal plate clamps



NIEUW
NOUVEAU
NEW



Code	Opening / Ouverture	Omschrijving / Description / Description	WLL/CMU kg	Bruto € /	EAN Code
PKHOR03505	0 - 35 mm	Kleine bek / Petite ouverture / Small yaw opening	500	102,00	
PKHOR06010	0 - 60 mm		1000		165,00
PKHOR06015	0 - 60 mm		1500	190,00	
PKHOR06020	0 - 60 mm		2000		240,00
PKHOR06030	0 - 60 mm		3000	279,00	
PKHOR06040	0 - 60 mm		4000		418,00
PKHOR06050	0 - 60 mm		6000	450,00	

Code	Opening / Ouverture	Omschrijving / Description / Description	WLL/CMU kg	Bruto € /	EAN Code
PKHOR010010	0 - 100 mm	Grote bek / Ouverture large / Large yaw opening	1000	191,00	
PKHOR010015	0 - 100 mm		1500		203,00
PKHOR010020	0 - 100 mm		2000	261,00	
PKHOR010030	0 - 100 mm		3000		278,00
PKHOR010040	0 - 100 mm		4000	446,00	
PKHOR010050	0 - 100 mm		5000		503,00
PKHOR0100100	0 - 100 mm		10000	713,00	

Profiel en buizenklemmen - Pinces à profile et tubes - Profile and tube clamps



Code	Opening / Ouverture	Omschrijving / Description / Description	WLL/CMU kg	Bruto € /	EAN Code
PKBK05	0 - 25 mm	Profiel en inwendige buizen klem met zwaar gesmeed hijsoog Pince à profilé et tube interne avec œillet de levage forgé lourd Profile and internal tube clamp with heavy forged lifting eye	500	130	
PKBK10	0 - 25 mm		1000		
PKBK20	0 - 30 mm		2000	239	
PKBK30	0 - 38 mm		3000		
PKBK50	0 - 40 mm		5000	701	

16

Railklemmen - Pince à rail - Railway clamps

Railklemmen - Pince à rail - Railway clamps



Code	Opening / Ouverture	Omschrijving / Description / Description	WLL/CMU kg	Bruto €	EAN CODE
BKTRC2T	0 - 25 mm	Profiel en inwendige buizen klem met zwaar gesmeed hijsoog Pince à profilé et tube interne avec œillet de levage forgé lourd	2000	259,00	
BKTRC4T	0 - 45 mm	Profile and internal tube clamp with heavy forged lifting eye	4000	430	

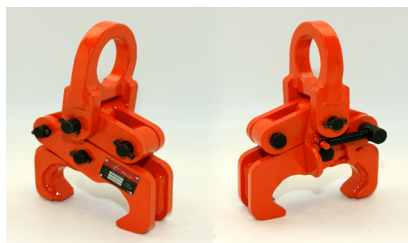

Railklem
Pince à rail
Rail clamp

NIEUW
NOUVEAU
NEW



Profiel en buizenklem
Pinces à profiles et tubes
Profile and tube clamp

NIEUW
NOUVEAU
NEW



Platenklem
Pince à tôle
Plate clamp

Loopkatten met grotere flensbreedte op aanvraag - Chariots manuels d'autre largeurs de fer sur demande - Plain trolleys with larger width of flange on demand.

Duwloopkatten – Chariots à manuel à direction par pousser - Plain trolleys

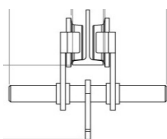

Code	Flensbreedte / Largeur de fer / Width of flange	WLL/CMU kg	Bruto €	EAN CODE
LKDS005	64 - 140mm	500	72,00	
LKDS010	64 - 300mm	1000	119,00	
LKDS020	76 -300mm	2000	181,00	
LKDS030	76 - 203 mm	3000	305,00	
LKDS050	88 - 300mm	5000	406,00	
LKDS100	125 - 300mm	10000	704,00	

Duwloopkatten – Chariots à manuel à direction par pousser - Plain trolleys OEM

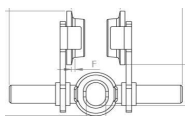

Code	Flensbreedte / Largeur de fer / Width of flange	WLL/CMU kg	Bruto €	EAN CODE
LKDS005OEM	50 - 203 mm	500	70,00	
LKDS010OEM	50 - 203 mm	1000	107,00	
LKDS020OEM	66 - 203 mm	2000	132,00	
LKDS030OEM	74 - 200 mm	3000	216,00	
LKDS050OEM	90 - 300 mm	5000	319,00	

Mechanische haspelloopkatten – Chariots manuel à direction par chaîne – Geared trolleys



Code	Flensbreedte / Largeur de fer / Width of flange	WLL/CMU kg	Bruto €	EAN CODE
LKHS010	62-128 mm	1000	254,00	
LKHS020	74-154 mm	2000	348,00	
LKHS030	82-154 mm	3000	570,00	
LKHS050	98-194 mm	5000	763,00	
LKHS100	125-300 mm	10000	1277,00	

Bedieningshoogte / Hauteur de service / Service height: 2,5 m

Dommekrachten met zwengel - Crics à crémaillère avec manivelle - Rack jacks

Andere types (DIN) steeds verkrijgbaar op aanvraag. Autres types (DIN) toujours disponible sur demande. - Other types (DIN) always available on request.

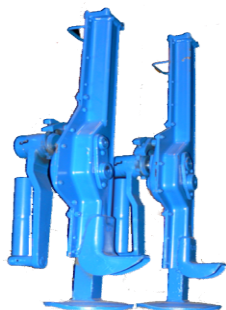

Code	WLL/CMU kg	Bruto €	EAN CODE
DKS025	2500	289,30	
DKS050	5000	365,20	
DKS100	10000	554,40	
DKS150	16000	1.328,80	
DKS200	20000	1.520,20	

Code	WLL/CMU Ton Teen / Doigt / Toe	WLL/CMU Ton Kop / Tasse / Head	Hoogte/Hauteur/ Height	Bruto €	EAN CODE
PKTV025	2,5 T	5 T	232 mm	373	
PKTV050	5 T	10 T	280 mm	597	
PKTV100	10 T	20 T	320 mm	934	
PKTV150	15 T	30 T	340 mm	1180	
PKTV250	25 T	50 T	350 mm	1963	



NIEUW
NOUVEAU
NEW









Beschikbaarheid op aanvraag / Disponibilite sur demande /
Availability on request



Code	WLL/CMU Ton	Bruto €	EAN CODE
PK02T	2 T	42,00	
PK03T	4 T	52,00	
PK05T	6 T	60,00	
PK08T	8 T	72,00	
PK10T	10 T	82,00	
PK12T	12 T	92,00	
PK16T	16 T	105,00	
PK20T	20 T	140,00	
PK32T	32 T	185,00	
PK50T	50 T	255,00	
PK100T	100 T	On request	

Elektrische kettingtakels - Palans électrique - Electric chain hoists 400V - 50Hz - 3 FASE / 3 PHASE PROLIFT

Standaard hijshoogte / Hauteur de levage standard / Standard hoist height: 3 m

Code	WLL/CMU kg	m/min	Ketting / Chaîn / Chain	Bruto €	EAN CODE
ETPL3F0250-7-2.3	250	7 - 2.3	5 x 15mm	1.468,00	
ETPL3F0500-7-2.3	500	7,6 - 2.5	6,3 x 19	1.556,00	
ETPL3F1000-5-1.7	1000	5 - 1.7	8 x 24	1.849,00	
ETPL3F2000-2.5-0.8	2000	2.5 - 0.85	8 x 24	2.084,00	
ETPL3F3000-6-2	3000	6 - 2	11,2 x 34	3.023,00	
ETPL3F5000-3-1	5000	3 - 1	11,2 x 35	3.552,00	

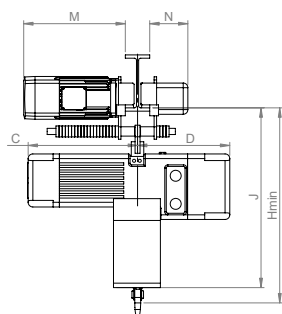
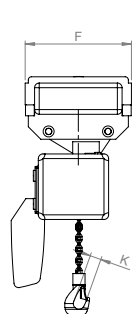





Capaciteit (t)	Classificatie FEM/ISO	Belastingsgraad	Hijssnelheid (m/min)	Hijsmotor (kw)	Travelling speed (m/min)	Loopkat motor (kw)	Balk flens (mm)	Hijsketting afmeting	Aantal hijsparten	Netto gewicht met 3m hijsketting (kg)
0.25	3m/M6	33.4%/16.6%	7.0/2.3	0.9/0.3	20/6.7	0.2/0.067	135	Ø 5x15	1	95
0.5	2m/M5	26.6%/13.4%	7.6/2.5	0.9/0.3	20/6.7	0.2/0.067	135	Ø 6.3x19	1	96
1	2m/M5	26.6%/13.4%	5.0/1.7	1.1/0.37	20/6.7	0.2/0.067	135	Ø 8.0x24	1	100
2	2m/M5	26.6%/13.4%	2.5/0.85	1.1/0.37	20/6.7	0.4/0.13	135	Ø 8.0x24	2	111
3	2m/M5	26.6%/13.4%	6.0/2.0	3.0/1.0	18 / 16	0.4/0.13	140	Ø 11.2x34	1	180
5	2m/M5	26.6%/13.4%	3.0/1.0	3.0/1.0	18 / 16	0.75/0.25	142	Ø 11.2 x 34	2	222

Capaciteit (t)	Hmin	A	B	C	D	F	J	K		M	N
0.25	398	142	102	329	273	340	650	31		336	135
0.5	398	142	102	329	273	340	650	31		336	135
1	460	142	102	349	273	340	650	38	336		135
2	650	185	59	349	273	340	650	45	338		135
3	525	185	165	471	336	370	810	45	340		140
5	860	240	110	471	336	410	850	61	410		142

Elektrische kettingtakels - Palans électrique à chaîne - Electric chain hoists MONOFASE / MONOPHASE - 230V - 50 Hz





Standaard hijshoogte / Hauteur de levage standard / Standard hoist height: 6 m

Code	WLL/CMU kg	Volt	Hijshoogte Hauteur de levage	Bruto €	EAN CODE
ETPLSF500	500	220	6 m	1.230,00	
ETPLSF1000	1000		6 m	1.420,00	
ETPLSF2000	2000		6 m	1.550,00	

ETPLSF200MINI	200	220	6 m	1.175,00	
---------------	-----	-----	-----	----------	---

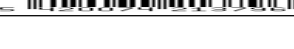

Elektrische loopkatten - Charriots électriques - Electric beam trolleys 400V - 50Hz - 3 FASE / 3 PHASE PROLIFT

Code	WLL/CMU kg	m/min	Balk Flens / Largeur de poutre /	Bruto €	EAN CODE
ETPL3F0500ELK	500	20 - 6,7	74 - 140 mm	988,00	
ETPL3F1000ELK	1000	20 - 6,7	74 - 140 mm	1.067,00	
ETPL3F2000ELK	2000	20 - 6,7	74 - 140 mm	1.171,00	
ETPL3F3000ELK	3000	18 - 6	100 - 170 mm	1.301,00	
ETPL3F5000ELK	5000	18 - 6	100 - 170 mm	1.525,00	

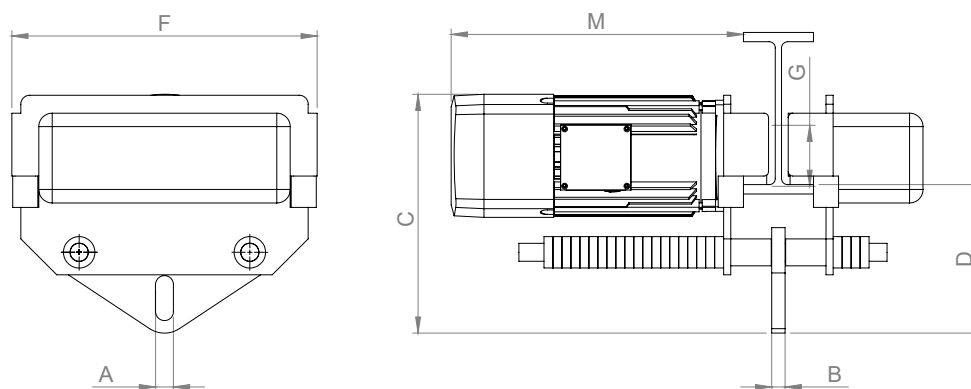





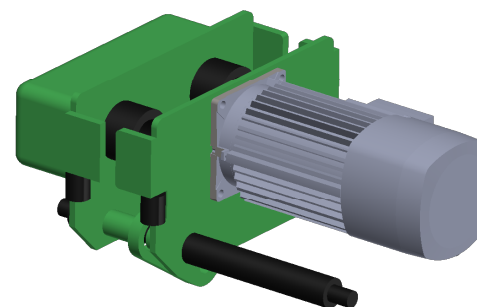

Model	Capaciteit (t)	Snelheid	Motor snelheid	Balk flens	Netto gewicht (kg)
ETPL3F1000ELK	1	20.0/6.7	0.2/0.67	74-140	33
ETPL3F2000ELK	2	20.0/6.7	0.4/0.13	74-140	40
ETPL3F3000ELK	3	18.0/6.0	0.4/0.13	100-170	56
ETPL3F5000ELK	5	18.0/6.0	0.75/0.25	100-170	76

Model	Capaciteit (t)	A	B	C	D	F	G	M	N
ETPL3F1000ELK	1	24	14	260	145	340	68	336	405
ETPL3F2000ELK	2	30	14	280	140	340	75	338	410
ETPL3F3000ELK	3	36	16	340	210	370	96	340	410
ETPL3F5000ELK	5	40	22	380	205	410	110	410	410









Mat. :	Own weight : KG
SWL :	Norm : EN ISO 12100:2010 + EN 60204-1 : 2006+A 1 : 2009
Sup. : Vabotec Bvba	ART N° :
Title : Elektrische loopkat	

Staaldraadtakels - Tireurs à câble - Wire rope pulling hoists

Code	WLL/CMU kg	Lengte / Longueur du câble / Length of cable	Bruto €	EAN CODE
STM080020	800	20 m	272,00	
STM160020	1600		409,00	
STM320020	3200		590,00	
STM540020	5400		1.206,00	
STM080030	800	30 m	305,00	
STM160030	1600		426,00	
STM320030	3200		633,00	

Andere lengtes op aanvraag - autre longueurs sur demande - other lengths on request













Staaldraadtakels - Tireurs à câble - Wire rope pulling hoists
Kabels / Câbles / Cables

Code	WLL/CMU kg	Lengte / Longueur du câble / Length of cable	Bruto €	EAN CODE
STMKA080020	800	20 m	77,00	
STMKA080030	800	30 m	105,00	
STMKA160020	1600	20 m	120,00	
STMKA160030	1600	30 m	175,00	
STMKA320020	3200	20 m	252,00	
STMKA320030	3200	30 m	348,00	
STMKA540020	5400	20 m	403,00	

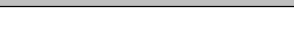

Kabelschijven - Poullies - Snatch blocks

Afwijkende tonnages worden niet vermeld. Prijzen steeds verkrijgbaar op aanvraag!
Des capacités irrégulières ne sont pas mentionnées. Prix toujours disponible sur demande! -

Code	WLL/CMU kg	Ø	Bruto €	EAN CODE	
HEAVY DUTY haakophanging / suspension crochet / hook suspension					
KAKHLH02075	2000	7 - 9 mm	139,76		
KAKHLH04115	4000	10 - 12 mm	246,40		
KAKHLH08150	8000	16 - 19 mm	481,25		
KAKHLH08152	8000	20 -22 mm	478,17		
KAKHLH08202	8000	20 - 22 mm	691,46		
KAKHLH10254	10000	24 - 26 mm	1081,39		



Laadindicators - Indicateurs de charge - Load indicators digitale

Afwijkende tonnages worden niet vermeld. Prijzen steeds verkrijgbaar op aanvraag!
 Des capacités irréguliers ne sont pas mentionnées. Prix toujours disponible sur demande! -
 Deviant capacities are not mentioned. Price always available on request!

Beschikbaar met en zonder handheld - Disponible avec et sans ordinateur de poche - Available with and without handheld
Afbeelding ter illustratie - Image pour illustration - Image for illustration only.



Code	WLL/ CMU kg	Bruto €	EAN CODE	
DLI010	1000	804		
DLI020	2000	900		
DLI030	3000	988		
DLI050	5000	1215		
DLI100	10000	1740		
DLI200	20000	2280		

Hobby Lier voor in de bouw - Treuil de construction Hobby - Hobby construction winch 230Volt



Code	WLL/CMU kg	L	Bruto €	EAN CODE
ELIPA20012M	200	12m	132,00	
ELIPA40012M	400	12m	184,00	
ELIPA80012M	800	12m	277,00	

Andere lengtes op aanvraag - autre longueurs sur demande - other lengths on request

Stellingier - Treuil de rayonnage - Scaffold winch 230Volt



Code	WLL/CMU kg	L	Bruto €	EAN CODE
ELIST250A	250	12m	677,00	
ELIST300A	300	12m	797,00	
ELIST500A	500	12m	882,00	

Andere lengtes op aanvraag - autre longueurs sur demande - other lengths on request

Bouwlier industrieel - Treuil de construction industriel - Industrial construction winch 230Volt



Code	WLL/CMU kg	L	Bruto €	EAN CODE
ELIPAYT200400	200/400	35m/17,5	537,00	
ELIPAYT300600	0,50	35m/17,5	734,00	
Code	WLL/CMU kg	L	Bruto €	EAN CODE
ELIPAYT-LKDS-200600	200/600	70mm tot 300mm	282,00	

Andere lengtes op aanvraag - autre longueurs sur demande - other lengths on request

Elektrische lier eindloos - Treuil électrique sans fin - Endless electrical winch 230Volt



Code	WLL/CMU kg	L	Bruto €	EAN CODE
ELIPAENDLESS150	150/300	< 200m	734,00	

ELIPAHPE50M	150	< 200m	188,00	
-------------	-----	--------	--------	--



Andere lengtes op aanvraag - autre longueurs sur demande - other lengths on request

Met hijstouw - Avec corde de levage - With lifting cord



Beschikbaarheid van onderstaande lieren op aanvraag / Disponibilité des treuils ci-dessous sur demande / Availability of below winches on request

Alle trailerlieren kunnen op aanvraag ook geleverd worden met kabel / Toutes treuils peuvent être livrées sur demande avec câble /

Trailerlieren geremd - Treuils manuel de traction - Braked winches



Code	Omschrijving / Description / Description	WLL / CMU	Bruto €	EAN CODE
TLGB0054	Trailerlier zonder kabel / Treuil sans câble / Winch without cable	540 kg	80,00	
TLGB0081		810 kg		102,00
TLGB0117		1170 kg	117,00	

Trailerlieren niet geremd - Treuils manuel sans traction - Non braked winches PROLIFT OEM

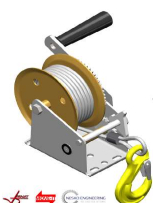

Code	Omschrijving / Description / Description	WLL / CMU	Bruto €	EAN CODE
TLNGU080	Trailerlier met kabel / Treuil avec câble / Winch with cable	360 kg	35,00	
TLNGU120		540 kg		42,00
TLNGU160		720 kg	56,00	
TLNGU250		1125 kg		64,00



Manuele brano hijslieren - Treuils de levage manuel brano - Manual hoisting winches brano



Code	Omschrijving / Description / Description	WLL/CMU	Bruto €	EAN CODE
LIBRANO0750	Manuele hijslier / Treuils de levage manuel / Manual hoisting winch	500 kg	417,00	
LIBRANO1000		1000 kg		796,00

Zwenkkransen - Potences - Jib cranes

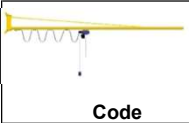
Afwijkende tonnages en modellen worden niet vermeld. Prijzen steeds verkrijgbaar op aanvraag!
Des capacités et modèles irréguliers ne sont pas mentionnées. Prix toujours disponible sur demande!
Deviant capacities and models are not mentioned. Price always available on request!

 Code	Vermogen / Capacité / Capacity	Uitlading / Portée / Span	 Code	Vermogen Capacité Force	Uitlading Portée Large jib
ZWKWPOO-E125/3	125 kg	3 m	ZWKWPBH-Z125/2	125 kg	2 m
ZWKWPOO-E125/4	125 kg	4 m	ZWKWPBH-Z125/3	125 kg	3 m
ZWKWPOO-E125/5	125 kg	5 m	ZWKWPBH-Z125/4	125 kg	4 m
ZWKWPOO-E125/6	125 kg	6 m	ZWKWPBH-Z125/5	125 kg	5 m
ZWKWPOO-E125/7	125 kg	7 m	ZWKWPBH-Z125/6	125 kg	6 m
ZWKWPOO-E125/8	125 kg	8 m	ZWKWPBH-Z125/7	125 kg	7 m
			ZWKWPBH-Z125/8	125 kg	8 m
ZWKWPOO-F250/3	250 kg	3 m			
ZWKWPOO-F250/4	250 kg	4 m	ZWKWPBH-W250/2	250 kg	2 m
ZWKWPOO-F250/5	250 kg	5 m	ZWKWPBH-W250/3	250 kg	3 m
ZWKWPOO-F250/6	250 kg	6 m	ZWKWPBH-W250/4	250 kg	4 m
ZWKWPOO-F250/7	250 kg	7 m	ZWKWPBH-W250/5	250 kg	5 m
ZWKWPOO-F250/8	250 kg	8 m	ZWKWPBH-W250/6	250 kg	6 m
			ZWKWPBH-W250/7	250 kg	7 m
			ZWKWPBH-W250/8	250 kg	8 m
ZWKWPOO-G500/3	500 kg	3 m			
ZWKWPOO-G500/4	500 kg	4 m			
ZWKWPOO-G500/5	500 kg	5 m	ZWKWPBH-X500/2	500 kg	2 m
ZWKWPOO-G500/6	500 kg	6 m	ZWKWPBH-X500/3	500 kg	3 m
ZWKWPOO-G500/7	500 kg	7 m	ZWKWPBH-X500/4	500 kg	4 m
ZWKWPOO-G500/8	500 kg	8 m	ZWKWPBH-X500/5	500 kg	5 m
			ZWKWPBH-X500/6	500 kg	6 m
			ZWKWPBH-X500/7	500 kg	7 m
			ZWKWPBH-X500/8	500 kg	8 m
ZWKWPOO-H1000/3	1000 kg	3 m			
ZWKWPOO-H1000/4	1000 kg	4 m			
ZWKWPOO-H1000/5	1000 kg	5 m			
ZWKWPOO-H1000/6	1000 kg	6 m	ZWKWPBH-Y1000/2	1000 kg	2 m
ZWKWPOO-H1000/7	1000 kg	7 m	ZWKWPBH-Y1000/3	1000 kg	3 m
ZWKWPOO-H1000/8	1000 kg	8 m	ZWKWPBH-Y1000/4	1000 kg	4 m
			ZWKWPBH-Y1000/5	1000 kg	5 m
			ZWKWPBH-Y1000/6	1000 kg	6 m
			ZWKWPBH-Y1000/7	1000 kg	7 m
			ZWKWPBH-Y1000/8	1000 kg	8 m
			ZWKWPBH-2000/3	2000 kg	3 m
			ZWKWPBH-2000/4	2000 kg	4 m
			ZWKWPBH-2000/5	2000 kg	5 m



Zwenkkranen - Potences - Jib cranes

*Afwijkende tonnages en modellen worden niet vermeld. Prijzen steeds verkrijgbaar op aanvraag!
Des capacités et modèles irréguliers ne sont pas mentionnées. Prix toujours disponible sur demande!
Deviant capacities and models are not mentioned. Price always available on request!*

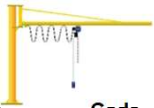
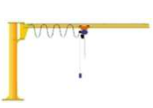
 Code	Vermogen Capacité Force	Uittlading Portée Large jib	 Code	Vermogen Capacité Force	Uittlading Portée Large jib
ZWKKPOO-A125/3	125 kg	3 m	ZWKKPBH-S125/2	125 kg	2 m
ZWKKPOO-A125/4	125 kg	4 m	ZWKKPBH-S125/3	125 kg	3 m
ZWKKPOO-A125/5	125 kg	5 m	ZWKKPBH-S125/4	125 kg	4 m
ZWKKPOO-A125/6	125 kg	6 m	ZWKKPBH-S125/5	125 kg	5 m
ZWKKPOO-A125/7	125 kg	7 m	ZWKKPBH-S125/6	125 kg	6 m
ZWKKPOO-A125/8	125 kg	8 m	ZWKKPBH-S125/7	125 kg	7 m
			ZWKKPBH-S125/8	125 kg	8 m
ZWKKPOO-B250/3	250 kg	3 m			
ZWKKPOO-B250/4	250 kg	4 m	ZWKKPBH-T250/2	250 kg	2 m
ZWKKPOO-B250/5	250 kg	5 m	ZWKKPBH-T250/3	250 kg	3 m
ZWKKPOO-B250/6	250 kg	6 m	ZWKKPBH-T250/4	250 kg	4 m
ZWKKPOO-B250/7	250 kg	7 m	ZWKKPBH-T250/5	250 kg	5 m
ZWKKPOO-B250/8	250 kg	8 m	ZWKKPBH-T250/6	250 kg	6 m
			ZWKKPBH-T250/7	250 kg	7 m
			ZWKKPBH-T250/8	250 kg	8 m
ZWKKPOO-C500/3	500 kg	3 m			
ZWKKPOO-C500/4	500 kg	4 m			
ZWKKPOO-C500/5	500 kg	5 m	ZWKKPBH-U500/2	500 kg	2 m
ZWKKPOO-C500/6	500 kg	6 m	ZWKKPBH-U500/3	500 kg	3 m
ZWKKPOO-C500/7	500 kg	7 m	ZWKKPBH-U500/4	500 kg	4 m
ZWKKPOO-C500/8	500 kg	8 m	ZWKKPBH-U500/5	500 kg	5 m
			ZWKKPBH-U500/6	500 kg	6 m
			ZWKKPBH-U500/7	500 kg	7 m
			ZWKKPBH-U500/8	500 kg	8 m
ZWKKPOO-D1000/3	1000 kg	3 m			
ZWKKPOO-D1000/4	1000 kg	4 m			
ZWKKPOO-D1000/5	1000 kg	5 m			
ZWKKPOO-D1000/6	1000 kg	6 m	ZWKKPBH-V1000/2	1000 kg	2 m
ZWKKPOO-D1000/7	1000 kg	7 m	ZWKKPBH-V1000/3	1000 kg	3 m
ZWKKPOO-D1000/8	1000 kg	8 m	ZWKKPBH-V1000/4	1000 kg	4 m
			ZWKKPBH-V1000/5	1000 kg	5 m
			ZWKKPBH-V1000/6	1000 kg	6 m
			ZWKKPBH-V1000/7	1000 kg	7 m
			ZWKKPBH-V1000/8	1000 kg	8 m
			ZWKKPBH-VA2000/3	2000 kg	3 m
			ZWKKPBH-VA2000/4	2000 kg	4 m
			ZWKKPBH-VA2000/5	2000 kg	5 m



ALGEMENE VOORWAARDEN**Artikel 1 – Toepasselijkheid van de Algemene Voorwaarden**

Elke bestelling brengt de aanvaarding van deze algemene voorwaarden door de koper met zich mee en de verzaking aan diens eigen algemene voorwaarden. Afwijkingen aan deze voorwaarden zijn slechts tegenstelbaar aan de verkoper mits de aanvaarding van deze afwijkingen schriftelijk is bevestigd door de verkoper.

Artikel 2 – Ontstaan van de overeenkomst

De koopovereenkomst komt pas tot stand na schriftelijke bevestiging door de verkoper van de door de koper geplaatste bestelling. Indien de verkoper na het ontvangen van de bestelling overgaat tot levering uit de magazijnvoorraad zonder deze bestelling schriftelijk te bevestigen, komt de overeenkomst echter tot stand op het ogenblik van de levering.

Artikel 3 – Annulering

Eenzijdige annulering door de koper is ongeldig, tenzij deze annulering schriftelijk wordt aangevraagd en de verkoper zich schriftelijk met een dergelijke annulering akkoord verklaard heeft. De koper is gehouden de reeds door de verkoper gemaakte kosten te vergoeden evenals de kosten welke voortvloeien uit de annulering; deze vergoeding bedraagt ten minste 35 €, het staat de verkoper vrij een hoger bedrag van gemaakte kosten te bewijzen. Naast de kosten dewelke voortvloeien uit de annulering, zal de koper aan verkoper tevens een vergoeding betalen gelijk aan 20 % van de globale prijs vermeld in de offerte, met een minimum van 75,00 €.

Artikel 4 – Opdrachten / Raadgevingen

De in tekeningen, folders, catalogi of andere documenten opgenomen gegevens hebben een informatief karakter. Deze gegevens zijn niet bindend. Enkel de in de offerte, of bij gebreke daaraan, de in de factuur opgenomen gegevens zijn bindend. Elke door verkoper gemaakte tekening of plan, elk ontwerp of enig model is strikt vertrouwelijk en blijft ten allen tijde eigendom van verkoper. In geval van annulering van de opdracht zal degene voor wie een ontwerp is gemaakt, dit onmiddellijk terug ter beschikking stellen aan verkoper. Het is de koper of degene voor wie het model of de tekening gemaakt is, geenszins toegelaten de tekening of het model te gebruiken of aan derden door te geven. Bij gebruik ervan buiten het weten van verkoper, heeft deze het recht vergoeding te vorderen van elke schade, daarinbegrepen en niet beperkt daartoe, de globale prijs van het uitgevoerde ontwerp. Dit geldt onverminderd het recht van verkoper om van elke derde die bij het gebruik betrokken is de stopzetting te vorderen van het gebruik dat wordt gemaakt van het werk van verkoper. Over de door de koper verstrekte gegevens of aanwijzingen wordt door de verkoper geen enkele aansprakelijkheid aanvaard. Het is de koper niet toegestaan enige aanduiding omtrent merken, handelsnamen, octrooien of andere intellectuele of industriële eigendomsrechten van het door de verkoper geleverde te verwijderen of te wijzigen, daaronder begrepen aanduidingen omtrent het vertrouwelijk karakter en geheimhouding van het geleverde. Indien de verkoper technische raadgevingen verschaft, doet hij dit naar best vermogen doch zonder enige verbintenis of aansprakelijkheid op te nemen ten aanzien van de koper.

Artikel 5 – Leveringstermijn

Tenzij anders overeengekomen, zijn de leveringstermijnen slechts als aanwijzing gegeven en zij houden geen enkele garantie in uit hoofde van de verkoper. Een eventuele vertraging in de levering kan in geen geval tot de betaling van schadevergoeding of tot ontbinding van de overeenkomst aanleiding geven. Indien partijen bindende termijnen zijn overeengekomen en indien goederen niet tijdig zijn geleverd, zal de verkoper slechts gehouden zijn tot schadevergoeding, behoudens ingeval van grove fout, indien dergelijke schadevergoeding op voorhand en schriftelijk was overeengekomen. In geen enkel geval zal de schadevergoeding wegens vertraging in de levering meer dan 10% van de globale prijs bedragen.

Artikel 6 – Overmacht - exoneratie

Zelfs indien partijen een schadevergoeding voor vertraging in de levering zijn overeengekomen als bepaald in artikel 5, is deze schadevergoeding niet verschuldigd wanneer de vertraging haar oorzaak vindt in oorzaken vreemd aan verkoper, zoals, zonder dat deze lijst beperkend is, ziekte onder het personeel, staking van het personeel evenals staking van derde als bv de vervoersmaatschappij waar Vabotec mee samen werkt. De verkoper heeft in deze gevallen de keuze om ofwel de levering op te schorten tot deze buitengewone omstandigheden een einde hebben genomen ofwel aan de overeenkomst te verzaken, zonder dat zij aan koper enige vergoeding verschuldigd is, nog gehouden is tot teruggave van hetgeen aan verkoper reeds is voldaan in uitvoering van de overeenkomst. Verkoper is ook op geen enkele wijze aansprakelijk voor enige fout of bedrog gepleegd door haar aangestelden of uitvoeringsagenten.

Artikel 7 – Eigendomsvoorbehoud

De geleverde goederen blijven onze eigendom tot het bedrag van de facturen die erop betrekking hebben, alsook alle desbetreffende interesten, kosten en belastingen volledig zijn betaald. De risico's zijn echter ten laste van de koper vanaf het moment dat de goederen onze magazijnen verlaten.

Artikel 8 – Prijzen

Behoudens tegengesteld geschreven beding is ieder aanbod van de verkoper vrijblijvend. Tenzij schriftelijk anders overeengekomen, zijn de opgegeven prijzen exclusief B.T.W. Ook na aanvaarding van de bestelling kan de verkoper zijn prijzen aanpassen indien er zich tussen de offerte en de levering wijzigingen voordoen in de kosten van energie, grondstoffen, in de lonen of in één van de andere bestanddelen van zijn kostprijs.



Artikel 9 – Betaling

Tenzij anders overeengekomen zijn alle facturen en debetnota's betaalbaar uiterlijk 30 dagen na uitgiftedatum in de maatschappelijke zetel van de verkoper of op de post- of bankrekening door hem aangeduid. Het bedrag van elke factuur die niet volledig betaald is op de vervaldag wordt van rechtswege en zonder ingebrekestelling verhoogd met een forfaitaire schadevergoeding gelijk aan 15% van dit bedrag met een minimum van 75,00 €, vermeerderd met vergoedende intresten op de globale prijs vanaf de vervaldatum van de factuur ten belopen van 10 % per jaar. Bij niet-betaling van één of meerdere facturen is de verkoper na ingebrekestelling aan het adres van de koper geenszins gehouden de door hem opgenomen prestaties uit te voeren, en dit zolang koper niet voldoet aan zijn betalingsverplichtingen. Bovendien kan de verkoper de ontbinding van rechtswege van de overeenkomst vaststellen bij eenvoudige schriftelijke kennisgeving acht dagen nadat een ingebrekestelling zonder gevolg is gebleven. De verkoper behoudt zich tevens het recht voor om naast de betaling van de globale prijs, het schadebeding en de intresten, betaling van de gedane kosten en vergoeding van de geleden schade te eisen.

Betwisting van facturen dient te gebeuren, op straffe van verval, schriftelijk en uiterlijk binnen 8 dagen vanaf de verzendingsdatum van de facturen. Elke betwisting na die termijn kan niet worden aanvaard.

Artikel 10 – Levering – Transport

De levering van de goederen gebeurt af fabriek verkoper. Het risico van de goederen gaat over bij levering. De in de offerte aangeduide prijzen zijn, behoudens indien deze uitdrukkelijk in de offerte opgenomen zijn, gebaseerd op levering af fabriek exclusief transportkosten en de kosten van verzekering daarvan. Indien de koper daarom vraagt, zal verkoper, zonder evenwel enige verantwoordelijkheid desbetreffend op te nemen en zonder dat daardoor het risico van de goederen slechts overgaat bij de effectieve aflevering, in naam en voor rekening van koper het transport organiseren.

Artikel 11 – Garantie

11.1 De verkoper geeft aan de koper de fabrieksgarantie die hij zelf verkreeg.

11.2 Daarbuiten is de verkoper slechts gehouden tot een garantie voor verborgen gebreken zoals hierna vermeld. Deze garantie is geldig gedurende drie maanden op de dag van de levering van de goederen. Tenzij de fabrieksgarantie ruimere waarborgen biedt, zijn de verplichtingen van de verkoper beperkt tot leveren van nieuwe vervangende onderdelen. De verkoper is geenszins gehouden tot enige andere vorm van schadevergoeding.

Elke aanspraak op garantie vervalt, noch kan van verkoper enige schadevergoeding of garantie gevorderd worden, in volgende gevallen:

- Indien de koper na vaststelling van het gebrek de geleverde goederen op eender welke wijze is blijven gebruiken, dan wel de verkoper niet onmiddellijk de gelegenheid is gegeven de gebreken te onderzoeken en zijn garantieverplichtingen na te komen.
- Indien de koper of een derde in opdracht van de koper zonder voorafgaande schriftelijke toestemming van de verkoper en zonder tegensprekelijke vaststelling van het verborgen gebrek, op welke wijze ook de goederen heeft gewijzigd, aangepast, gedemonteerd of hersteld.
- Indien door de koper niet tijdig is voldaan aan de reglementering inzake het wettelijk controletoezicht, en er geen tussentijdse attesten van een wettelijk keuringsorganisme kunnen worden voorgelegd.
- Indien de schade aan het geleverde goed, dan wel schade aan derden waarvan vergoeding zou worden gevorderd, het gevolg is van een onjuist dan wel een onoordeelkundig gebruik van de geleverde goederen.

Artikel 12 – Voortverkoop

In geval van voortverkoop verplicht de koper/wederverkoper er zich toe aan de nieuwe koper deze algemene voorwaarden kenbaar te maken.

Artikel 13 – Toepasselijk Recht / Bevoegdheid

Deze overeenkomst wordt uitsluitend beheerst door het Belgisch recht. Elk geschil met betrekking tot het afsluiten, de geldigheid, de interpretatie of de uitvoering van deze overeenkomst en van de overeenkomsten daaruit afgeleid, zal tot de uitsluitende bevoegdheid van de Rechtbanken van Antwerpen behoren, en in voorkomend geval tot die van de Vrederechter van het 7de kanton

Prijzen in deze prijslijst weergegeven zijn steeds per stuk en exclusief 21% BTW (indien van toepassing)

CONDITIONS GÉNÉRALES DE VENTE

Article 1 – Applicabilité des Conditions générales

Toute commande implique l'acceptation par l'acheteur des présentes conditions générales et la renonciation à ses propres conditions générales. Les écarts aux présentes conditions ne sont opposables au vendeur que si celui-ci confirme par écrit qu'il accepte ces écarts.

Article 2 – Entrée en vigueur du contrat

Le contrat de vente n'entre en vigueur qu'après confirmation écrite par le vendeur de la commande placée par l'acheteur. Si, après réception de la commande, le vendeur procède à la livraison de stock sans avoir confirmé cette commande par écrit, le contrat n'entre toutefois en vigueur qu'au moment de la livraison.

Article 3 – Annulation

Une annulation unilatérale par l'acheteur n'est valable que si elle a été demandée par écrit et que le vendeur s'est déclaré d'accord par écrit avec cette annulation. L'acheteur est tenu de rembourser les frais déjà encourus par le vendeur ainsi que les frais qui découlent de l'annulation; ce remboursement s'élève à un minimum de 35 € mais le vendeur est libre de prouver un montant supérieur pour les frais encourus. Outre les frais qui découlent de l'annulation, l'acheteur devra également payer au vendeur une indemnité égale à 20 % du prix global indiqué dans l'offre, avec un minimum de 75,00 €.

Article 4 – Commandes / Conseils

Les données reprises dans les dessins, les dépliants, les catalogues ou autres documents ont un caractère informatif. Ces données ne sont pas contraignantes. Seules les données reprises dans l'offre ou, faute d'offre, dans la facture, sont contraignantes. Tout dessin ou plan réalisé par le vendeur, tout projet ou modèle est strictement confidentiel et reste à tout moment la propriété du vendeur. En cas d'annulation de la commande, la personne pour qui un projet a été réalisé devra le remettre immédiatement à la disposition du vendeur. L'acheteur ou la personne pour qui le modèle ou le dessin a été réalisé n'est aucunement autorisé à utiliser le dessin ou le modèle ni à le transmettre à des tiers. En cas d'utilisation à l'insu du vendeur, ce dernier a le droit de réclamer une indemnité pour tout dommage, y compris mais non limité au prix global du projet réalisé. Ceci vaut sans préjudice du droit du vendeur d'exiger de tout tiers impliqué dans l'utilisation qu'il mette fin à l'utilisation faite du travail du vendeur. Le vendeur n'accepte aucune responsabilité au sujet des données ou indications fournies par l'acheteur. Il est interdit à l'acheteur d'enlever ou de modifier toute indication portant sur les marques, les dénominations commerciales, les brevets ou autres droits de propriété intellectuelle ou industrielle des biens livrés par le vendeur, y compris les indications portant sur le caractère confidentiel et la discrétion concernant les biens livrés. Si le vendeur fournit des conseils techniques, il le fera au mieux de ses capacités mais sans prendre d'engagement ou assumer de responsabilité à l'égard de l'acheteur.

Article 5 – Délai de livraison

Sauf convention contraire, les délais de livraison ne sont donnés qu'à titre indicatif et n'impliquent aucune garantie du chef du vendeur. Un retard éventuel dans la livraison ne peut en aucun cas donner lieu au paiement de dommages et intérêts ou à la résiliation du contrat. Si les parties ont convenu de délais contraignants et que les biens ne sont pas livrés à temps, le vendeur ne sera tenu qu'à des dommages et intérêts, sauf en cas de faute grave si ces dommages et intérêts avaient été convenus à l'avance et par écrit. En aucun cas, les dommages et intérêts pour retard de livraison ne s'élèveront à plus de 10% du prix global.

Article 6 – Force majeure – exonération

Même si les parties ont convenu de dommages et intérêts pour retard de livraison, comme stipulé à l'article 5, ces dommages et intérêts ne seront pas dus si le retard est la conséquence de causes indépendantes de la volonté du vendeur, telles que, sans que cette liste soit limitative, une maladie parmi le personnel, la grève du personnel ainsi que la grève de tiers comme par exemple la société de transport avec laquelle travaille Vabotec. Dans ces cas, le vendeur a le choix entre suspendre la livraison jusqu'à ce que ces circonstances extraordinaires aient pris fin et renoncer au contrat, sans être redevable à l'acheteur d'une indemnité quelconque, ni être tenu de lui restituer l'acompte qu'il aurait reçu en exécution du contrat. De même, le vendeur n'est nullement responsable d'une faute ou d'une fraude commise par ses préposés ou agents d'exécution.

Article 7 – Réserve de propriété

Les biens livrés restent notre propriété jusqu'à ce que le montant des factures les concernant ainsi que tous les intérêts, frais et taxes y afférents aient été entièrement payés. Les risques sont toutefois à charge de l'acheteur à partir du moment où les biens quittent nos magasins.

Article 8 – Prix

Sauf clause écrite contraire, chaque offre du vendeur est faite sans engagement. Sauf convention écrite contraire, les prix indiqués sont hors T.V.A. Même après l'acceptation de la commande, le vendeur peut adapter ses prix si, entre l'offre et la livraison, des modifications se sont produites dans les frais d'énergie, de matières premières, dans les salaires ou dans un des autres éléments de son prix coûtant.



Article 9 – Paiement

Sauf convention contraire, toutes les factures et notes de débit sont payables au plus tard 30 jours après la date d'émission, au siège social du vendeur ou sur le compte chèque postal ou bancaire indiqué par lui. Le montant de toute facture non entièrement payée à l'échéance est majoré de plein droit et sans mise en demeure d'une indemnité forfaitaire de 15% de ce montant, avec un minimum de 75,00 €, majoré des intérêts compensatoires sur le prix global à partir de la date d'échéance de la facture, à concurrence de 10 % par an. En cas de non-paiement d'une ou de plusieurs factures, le vendeur n'est aucunement tenu, après avoir envoyé une mise en demeure à l'acheteur, d'exécuter les prestations reprises par lui et ce, tant que l'acheteur n'a pas satisfait à ses obligations de paiement. Par ailleurs, le vendeur peut constater la dissolution du contrat de plein droit, par simple notification écrite huit jours après qu'une mise en demeure soit restée sans suite. Le vendeur se réserve également le droit de réclamer, en plus du paiement du prix global, de la clause de dommage et des intérêts, le paiement des frais encourus et d'une indemnité pour dommage subi. La contestation des factures doit se faire par écrit, à peine de déchéance, au plus tard dans les 8 jours qui suivent la date d'envoi des factures. Passé ce délai, aucune contestation ne sera plus acceptée.

Article 10 – Livraison – Transport

La livraison des biens a lieu départ usine vendeur. Le risque des biens est transmis lors de la livraison. Sauf s'ils sont repris expressément dans l'offre, les prix indiqués dans l'offre sont basés sur la livraison départ usine, frais de transport et frais d'assurance du transport non compris. Si l'acheteur en fait la demande, le vendeur organisera le transport au nom et pour le compte de l'acheteur, sans toutefois assumer de responsabilité quelconque à ce sujet et sans que de ce fait le risque des biens soit uniquement transmis lors de la livraison effective.

Article 11 – Garantie

11.1 Le vendeur donne à l'acheteur la garantie d'usine qu'il a lui-même reçue.

11.2 Par ailleurs, le vendeur n'est tenu à une garantie que pour les vices cachés comme indiqué ci-après. Cette garantie est valable pendant trois mois à partir de la livraison des biens. A moins que la garantie d'usine n'offre de garanties plus étendues, les obligations du vendeur sont limitées à la livraison de nouvelles pièces de remplacement. Le vendeur n'est aucunement tenu à toute autre forme d'indemnisation.

Toute prétention à une garantie est supprimée et aucune indemnisation ou garantie ne peut être réclamée au vendeur dans les cas suivants:

- Si, après avoir constaté le vice, l'acheteur a continué à utiliser les biens livrés de quelque façon que ce soit ou que le vendeur n'a pas immédiatement reçu l'occasion d'examiner les vices et de respecter ses obligations de garantie.
- Si l'acheteur ou un tiers, sur ordre de l'acheteur, a modifié, adapté, démonté ou réparé les biens de quelque façon que ce soit, sans l'autorisation écrite préalable du vendeur et sans constatation contradictoire du vice caché.
- Si l'acheteur n'a pas respecté à temps la réglementation en matière de contrôle légal et qu'aucun certificat intermédiaire d'un organisme de contrôle légal ne peut être produit.
- Si le dommage au bien livré ou le dommage à des tiers pour lequel une indemnité serait réclamée, est la conséquence d'une utilisation erronée ou mauvaise des biens livrés.

Article 12 – Revente

En cas de revente, l'acheteur/le revendeur s'engage à faire connaître les présentes conditions générales au nouvel acheteur.

Article 13 – Droit applicable / Compétence

Le présent contrat est régi exclusivement par le droit belge. Tout litige portant sur la conclusion, la validité, l'interprétation ou l'exécution du présent contrat et des contrats qui en découlent, appartiendra à la compétence exclusive des Tribunaux d'Anvers et, le cas échéant, à celle du Juge de Paix du 7e canton.

Article 14- Traduction

GENERAL TERMS AND CONDITIONS

Article 1 – Applicability of the General Terms and Conditions

Each order brings along the acceptance of these terms and conditions from the buyer and the omission of its own general conditions. Any deviations of these conditions are to be relied on against the seller if acceptance of these deviations is confirmed by written acknowledgement to the seller.

Article 2 – Closing of agreements

The sales contract shall inure after written confirmation from the seller of the order placed by the buyer. If, after receipt of the order, the seller proceeds to delivery from stock without written confirmation of the order, the contract shall inure on the moment of delivery.

Article 3 – Order cancellation

Unilateral cancellation by the buyer is invalid, unless it is requested by written demand and the seller agrees to such cancellation by his own written confirmation. The buyer is liable to make good and compensate any damages or costs made by the seller as well as any costs resulting from the cancellation; this reimbursement amounts to minimum 35€, but the seller is free to verify a higher amount of the costs that are made. Besides costs resulting from the cancellation, the buyer will furthermore pay the seller an indemnity equal to 20% of the global price mentioned in the offer, with a minimum of 75€.

Article 4 – Orders / Advice

All resumed data of drawings, pictures, leaflets, catalogues or other documents mentioned have an informative character. These data are non binding. Only data mentioned in the offer, or failing that, mentioned in the invoice are binding. Every drawing or design made by the seller, every project or model is strictly confidential and remains property of the seller at all time. In case of cancellation of the order, the person for who the design is made will immediately return it to the seller. The buyer or the person, for who the model or design is made, is under no circumstances authorised to pass them on to third parties. When used without knowledge of the seller, he has the right to claim compensation for any damages; this there included and not limited the global price of the executed design. This goes without prejudice the right of the seller to claim the immediate discontinuation of use of the data of the seller to any third parties involved. The seller accepts no responsibility whatsoever concerning the data or indications provided by the seller. It is strictly forbidden for the buyer to remove or modify any indications concerning trademarks, patents, brand names or any other intellectual or industrial property rights of goods provided by the seller; this includes indications concerning the confidential character and privacy of the provided goods. When the seller is providing technical advice, he will do so to the best of his abilities though without taking any engagement or liability with regard to the buyer.

Article 5 – Delivery time

Unless otherwise agreed, all delivery times mentioned are only given as an indication and do not imply any guarantee from the seller. Any possible delay in delivery cannot, under no circumstance, lead to compensation or liquidation of the contract. When both parties have agreed on stringent period of time and the goods are not delivered in time, the seller will only be held to compensation, subject to serious mistake, in case such compensation is agreed on and confirmed by both parties in written ahead of time. Under no circumstance this compensation will rise to more than 10% of the global price.

Article 6 – Force majeure / Exemption

Even when both parties agreed on compensation for a delay in delivery as determined in article 5, this compensation is not due when the cause of delay is beyond the will of the seller, as there are and this list is without any restrictions, sickness among personnel, strike among personnel as well as strike among third parties for example the transport company that Vabotec is cooperating with. In these cases, the seller has the choice to suspend the delivery until these exceptional circumstances have ended, or to waive the contract without owing any compensation to the buyer or without returning the amount already paid by the buyer in order of the execution of the contract. The seller is also not responsible for any error or fraud committed by those appointed or execution agents.

Article 7 – Reservation of ownership

The goods delivered remain property of Vabotec until the amount of all concerned invoices, this includes interest, costs and taxes, is fully paid for. However, the risks are chargeable to the buyer from the moment that the goods leave our warehouse.

Article 8 – Prices

Subject to any written agreement to the contrary, any offer made by the seller is without engagement. Unless agreed otherwise by written, the prices mentioned are excluding TVA. Even after acceptance of the order, the seller can adapt his prices when any modifications, between the offer and delivery, occur for example energy costs, raw materials, wages and salaries or other elements of his cost-price.

Article 9 – Payment

Unless agreed otherwise all invoices and debit notes are payable at the latest 30 days after issue date, at the registered head office of the seller or the post or bank account indicated by him. The amount of each invoice that is not fully paid for on the expiry day will be legally and without formal notice increased with an indemnity equal to 15% of that amount, with a minimum of 75€, increased with compensating interests on the global price starting from the expiry date of the invoice to the amount of 10% per year. In case of non-payment of one or more invoices, the seller, after sending formal notice to the buyer, is never kept by executing the performances taken up by him and this for as long as the buyer does not settle his obligation of payment. Moreover, the seller can establish the winding-up by law of the agreement with simple written notification eight days after a formal notice remained unsuccessful. The seller also reserves the right, besides the payment of the global price, to claim interests and damage clauses, payment of the made costs and reimbursement of the sustained damages. Disputes on invoices need to be done by written, with risk of forfeiture, and at the latest within 8 days starting from sending date of the invoices. Every dispute made after that period cannot be accepted again.



Article 10 – Delivery / Transportation

The delivery of the goods takes place ex-works seller. The risks of the goods are transmitted upon delivery. The prices indicated in the offer are based on delivery ex-works and transportation costs and the insurance thereof excluded, unless otherwise and explicitly stated in the offer. When requested by the buyer, the seller will organise transportation in name and for account of the buyer, this however without taking any responsibility and without the risks of the goods transmitted when effectively delivered.

Article 11 – Warranty

11.1 The seller gives the buyer the factory warranty that he has received himself.

11.2 Furthermore, the seller is only responsible to a warranty for hidden defects as stated further. This warranty is only valid during three months starting from the delivery of the goods. Unless the factory warranty offers more wide guarantees, the obligations of the seller are limited to the delivery of new replacement parts. The seller is not held, under any circumstance, to any other form of compensation.

Every claim to a warranty expires; neither can any compensation or warranty be claimed from the seller, in the following cases:

- When the buyer continued to use the goods after determination of the defect any way possible, or when the seller has not been given the immediate opportunity to examine the defects and to respects his warranty obligations.
- When the buyer or a third party by order of the buyer has modified, adjusted, dismantled or repaired the goods in any way without previous written permission of the seller and without contradictory determination of the hidden defect.
- When the buyer did not timely respect the regulations concerning the legal control supervision and when no provisional certificates of a legal control organism can be presented.
- When the damage to the goods delivered as the damage to third parties where compensation would be claimed, is the consequence of an incorrect and non-competent use of the goods delivered.

Article 12 – Resale

In case of resale, the buyer/reseller is obligated to make these general terms and conditions known to the new buyer.

Article 13 – Applicable law / Authority

This agreement is exclusively moderated by the Belgian law. Every dispute concerning the concluding, validity, interpretation or the execution of this agreements and derived agreements, belong exclusively to the authority of the Courts of Antwerp and when determined the Justice of the Peace of the 7th district.

Article 14 – Translation

In case of contrariety or differences in interpretation between the Dutch text and the translation thereof in English, it is the Dutch text that is always valid.

Prices mentioned in this price list are always per piece and VTA 21% not included (if applicable)